



4 WAN Enterprise Multi-WAN VPN QoS Router

Load Balancing, Bandwidth Management,
VPN & Network Security Management

English User's Manual

Product Manual Using Permit Agreement

[Product Manual (hereafter the "Manual") Using Permit Agreement] hereafter the "Agreement" is the using permit of the Manual, and the relevant rights and obligations between the users and Qno Technology Inc (hereafter "Qno"), and is the exclusion to remit or limit the liability of Qno. The users who obtain the file of this manual directly or indirectly, and users who use the relevant services, must obey this Agreement.

Important Notice: Qno would like to remind the users to read the clauses of the "Agreement" before downloading and reading this Manual. Unless you accept the clauses of this "Agreement", please return this Manual and relevant services. The downloading or reading of this Manual is regarded as accepting this "Agreement" and the restriction of clauses in this "Agreement".

【1】 Statement of Intellectual Property

Any text and corresponding combination, diagram, interface design, printing materials or electronic file are protected by copyright of our country, clauses of international copyright and other regulations of intellectual property. When the user copies the "Manual", this statement of intellectual property must also be copied and indicated. Otherwise, Qno regards it as tort and relevant duty will be prosecuted as well.

【2】 Scope of Authority of "Manual"

The user may install, use, display and read this "Manual on the complete set of computer.

【3】 User Notice

If users obey the law and this Agreement, they may use this "Manual" in accordance with "Agreement". If the users violate the "Agreement", Qno will terminate the using authority and destroy the copy of this "Manual". The "hardcopy or softcopy" of this Manual is restricted using for information, non-commercial and personal purpose. Besides, it is not allowed to copy or announce on any network computer. Furthermore, it is not allowed to disseminate on any media. It is not allowed to modify any part of the "file". Using for other purposes is prohibited by law and

it may cause serious civil and criminal punishment. The transgressor will receive the accusation possibly.

【4】 Legal Liability and Exclusion

【4-1】 Qno will check the mistake of the texts and diagrams with all strength. However, Qno, distributors, and resellers do not bear any liability for direct or indirect economic loss, data loss or other corresponding commercial loss to the user or relevant personnel due to the possible omission.

【4-2】 In order to protect the autonomy of the business development and adjustment of Qno, Qno reserves the right to adjust or terminate the software / Manual any time without informing the users. There will be no further notice regarding the product upgrade or change of technical specification. If it is necessary, the change or termination will be announced in the relevant block of the Qno website.

【4-3】 All the set parameters are examples and they are for reference only. You may also purpose your opinion or suggestion. We will take it as reference and they may be amended in the next version.

【4-4】 This Manual explains the configuration of all functions for the products of the same series. The actual functions of the product may vary with the model. Therefore, some functions may not be found on the product you purchased.

【4-5】 Qno reserves the right to change the file content of this Manual and the Manual content may not be updated instantly. To know more about the updated information of the product, please visit Qno official website.

【4-6】 Qno (and / or) distributors hereby declares that no liability will be born for any guarantee and condition of the corresponding information. The guarantee and condition include tacit guarantee and condition about marketability, suitability for special purposes, ownership, and non-infringement. The name of the companies and products mentioned may be the trademark of the owners. Qno (and/or) the distributors do not provide the product or software of any third party company. Under any circumstance, Qno and / or distributors bear no liability for special, indirect, derivative loss or any type of loss in the lawsuit caused by usage or information on the file, no matter the lawsuit is related to agreement, omission, or other tort.

【5】 Other Clauses

【5-1】 The potency of this Agreement is over any other verbal or written record. The invalidation of part or whole of any clause does not affect the potency of other clauses.

【5-2】 The power of interpretation, potency and dispute are applicable for the law of Taiwan. If



Enterprise Multi-WAN VPN QoS Router

there is any dissension or dispute between the users and Qno, it should be attempted to solve by consultation first. If it is not solved by consultation, user agrees that the dissension or dispute is brought to trial in the jurisdiction of the court in the location of Qno. In Mainland China, the "China International Economic and Trade Arbitration Commission" is the arbitration organization.

Content

I. Introduction.....	1
II. Multi- WAN VPN Router Installation	3
2.1 Systematic Setting Process	3
2.2 Setting Flow Chart	3
III. Hardware Installation	6
3.1 LED Signal.....	6
3.2 VPN Router Network Connection.....	8
IV. Login	9
V. Device Spec Verification, Status Display and Login Password and Time Setting	11
5.1 Home Page.....	11
5.1.1 WAN Status.....	11
5.1.2 Physical Port Status.....	12
5.1.3 System Information.....	13
5.1.4 Firewall Status.....	14
5.1.5 VPN Status	15
5.1.6 Log Setting Status	15
5.2 Change and Set Login Password and Time	16
5.2.1 Password Setting.....	16
5.2.2 Time.....	17
VI. Network.....	19
6.1 Network Connection	19
6.1.1 Host Name and Domain Name.....	20
6.1.2 LAN Setting.....	20
6.1.3 WAN & DMZ Settings	21
6.2 Multi- WAN Setting	35
6.2.1 Load Balance Mode.....	35
6.2.2 Network Detection Service	39
6.2.3 Protocol Binding.....	42
VII. Port Management	52
7.1 Setup.....	52
7.2 Port Status	55
7.3 IP/ DHCP.....	57
7.4 DHCP Status.....	59
7.5 IP & MAC Binding	61

7.6 IP Grouping.....	65
VIII. QoS (Quality of Service).....	66
8.1 Bandwidth Management.....	67
8.1.1 The Maximum Bandwidth provided by ISP.....	67
8.1.2 QoS.....	68
8.2 Session control.....	74
8.3 Smart QoS.....	77
IX. Firewall.....	79
9.1 General Policy.....	79
9.2 Restrict Application.....	83
9.3 Access Rule.....	85
9.4 Content Filter.....	89
X. VPN (Virtual Private Network).....	93
10.1. VPN.....	93
10.1.1. Display All VPN Summary.....	93
10.1.2. Add a New VPN Tunnel.....	98
10.1.3. PPTP Setting.....	128
10.1.4. VPN Pass Through.....	131
10.2. QnoKey.....	132
10.2.1. QnoKey Summary.....	132
10.2.2 Qnokey Group Setup.....	133
10.2.3 Qnokey Account List.....	136
10.3. QVM VPN Function Setup.....	138
10.3.1. QVM Server Settings.....	139
10.3.2. QVM Status.....	140
10.3.3. QVM Client Settings.....	142
XI. Virtue Route.....	144
11.1 Virtue Route Server (PPTP Server).....	146
11.2 Virtue Route Client.....	149
XII. Advanced Function.....	152
12.1 DMZ Host/ Port Range Forwarding.....	152
12.1.1 DMZ Host.....	152
12.1.2 Port Range Forwarding.....	153
12.1.3 Port Triggering.....	155
12.2 UPnP.....	157

12.3 Routing	159
12.3.1 Dynamic Routing	159
12.3.2 Static Routing	160
12.4 One to One NAT	162
12.5 DDNS- Dynamic Domain Name Service	164
12.6 MAC Clone	169
XIII. System Tool	170
13.1 Diagnostic	170
13.2 Firmware Upgrade	172
13.3 Setting Backup	173
13.4 SNMP	174
13.5 System Recover	176
XIV. Log	178
14.1 System Log	178
14.2 System Statistic	185
14.3 Traffic Statistic	187
14.4 IP/ Port Statistic	189
XV. Log out	192
Appendix I: User Interface and User Manual Chapter Cross Reference	193
Appendix II: Troubleshooting	196
(1) Block BT Download	196
(2) Shock Wave and Worm Virus Prevention	197
(3) Block QQLive Video Broadcast Setting	199
(4) ARP Virus Attack Prevention	201
Appendix III: Qno Technical Support Information	210

I. Introduction

Enterprise Multi-WAN VPN QoS Router (referred as VPN Router hereby) is a business level security router that efficiently integrates new generation multiple WAN-port devices. It meets the needs of both medium and large-scale enterprises, internet cafés, and communities, etc. Apart from its internet connectivity that suits the broadband market, VPN Router has a built-in 10/100Mbps QoS and VLAN switching board which enables it to fulfill most enterprise and internet cafe firewall needs.

VPN Router has 2-4 10/100 Base-T/TX Ethernets (RJ45) WAN ports. These WAN ports can support auto load balance mode, exclusive mode (remaining WAN balance), and strategy routing mode for high-efficiency network. They offer super flexibility for network set-up. Moreover, these WAN ports also support DHCP, fixed IP, PPPoE, transparent bridge, VPN connection, port binding, static routing, dynamic routing, NAT, one to one NAT, PAT, MAC Clone, as well as DDNS. As for LAN ports including one DMZ, they support 10/100 Base-T/TX Ethernet (RJ45) and provide the features of virtual route, Microsoft UPnP, VLAN, Multi Subnet, and transparent bridge mode. Internet IP addresses can also be used in intranet.

To fulfill the requirement for a highly secure and integrated firewall, VPN Router has a high-speed, high-efficiency four-core Intel IXP processor embedded. With high processing speed, plusing high standard SDRAM and Flash, VPN Router brings users super networking efficiency. Its processing speed and capacity are almost equal to those of expensive enterprise-level VPN Routers. This is why the device is so popular with modern enterprises.

In addition to internet connectability, for the broadband market, VPN Router has the function of VPN virtual network connection. It is equipped with a virtual private network hardware acceleration mode which is widely used in modern enterprises, and offers full VPN functionality.

Qno is a supporter of the IPSec Protocol. IPSec VPN provides DES, 3DES, AES-128 encryption, MD5, SH1 certification, IKE Pre-Share Key, or manual password interchange. VPN Router also supports aggressive mode. When a connection is lost, VPN Router will automatically re-connect. In addition, the device features NetBIOS transparency, and supports IP grouping for connections between clients and host in the virtual private network.

VPN Router offers the function of a standard PPTP server, which is equipped with connection setting status. Each WAN port can be set up with multiple DDNS at the same time. It is also capable of establishing VPN connections with dynamic IP addresses.

VPN Router also has unique QVM VPN- SmartLink IPSec VPN. Just input VPN server IP, user name, and password, and IPSec VPN will be automatically set up. Through VPN Router exclusive QVM function, users can set up QVM to work as a server, and have it accept other QVM series products from client ports. QVM offers easy VPN allocation for users; users can do it even without a network administrator. VPN Router enables enterprises to benefit from VPN without being troubled with technical and network management problems. The central control function enables the host to log in remote client computers at any time. Security and secrecy are guaranteed to meet the IPSec standard, so as to ensure the continuity of VPN service.

The advanced built-in firewall function enables VPN Router to resist most attacks from the Internet. It utilizes active detection technology SPI (Stateful Packet Inspection). The SPI firewall functions mainly within the network by dynamically inspecting each link. The SPI firewall also has a warning function for the application process; therefore, it can refuse links to non-standard communication protocols. VPN Router supports network address translation (NAT) function and routing modes. It makes the network environment more flexible and easier to manage.

Through web- based UI, VPN Router enables enterprises to have their own network access rules . To control web access, users can build and edit filter lists. It also enables users to ban or monitor websites according to their needs. By the filter setting and complete OS management, school and business internet management will be clearly improved. VPN Router offers various on-line SysLog records. It supports on-line management setup tools; it makes setting up networks easy to understand. It also reinforces the management of network access rules, VPN, and all other network services.

VPN Router fully protects the safety of communication between all offices and branches of an organization. It helps to free enterprises from increasing hacker intrusion. With an exclusive independent operation platform, users are able to set up and use a firewall without professional network knowledge. VPN Router setting up and management can be carried out through web browsers, such as IE, Netscape, etc.

II. Multi- WAN VPN Router Installation

In this chapter we are going to introduce hardware installation. Through the understanding of multi-WAN setting process, users can easily setup and manage the network, making VPN Router functioning and having best performance.

2.1 Systematic Setting Process

Users can set up and enable the network by utilizing bandwidth efficiently. The network can achieve the ideal efficientness, block attacks, and prevent security risks at the same time. Through the process settings, users can install and operate VPN Router easily. This simplifies the management and maintenance, making the user network settings be done at one time. The main process is as below:

1. Hardware installation
2. Login
3. Verify device specification and set up password and time
4. Set WAN connection
5. Set LAN connection: physical port and IP address settings
6. Set QoS bandwidth management: avoid bandwidth occupation
7. Set Firewall: prevent attack and improper access to network resources
8. Other settings: UPnP, DDNS, MAC Clone
9. Management and maintenance settings: Syslog, SNMP, and configuration backup
10. VPN (Virtual Private Network), QnoKey, QVM VPN function setting
11. Logout

2.2 Setting Flow Chart

Below is the description for each setting process, and the corresponding contents and purposes. For detailed functions, please refer to Appendix I: Setting Interface and Chapter Index.

#	Setting	Content	Purpose
1	Hardware installation	Configure the network to meet user's demand.	Install the device hardware based on user physical requirements.
2	Login	Login the device with Web Browser.	Login the device web- based UI.
3	Verify device specification	Verify Firmware version and working status.	Verify the device specification, Firmware version and working status.
	Set password and time	Set time and re-new password.	Modify the login password considering safe issue. Synchronize time with WAN.
4	Set WAN connection	Verify WAN connection setting, bandwidth allocation, and protocol binding.	Connect to WAN. Configure bandwidth to optimize data transmission.
5	Set LAN connection: physical port and IP address settings	Set mirror port and VLAN. Allocate and manage LAN IP.	Provide mirror port, port management and VLAN setting functions. Support Static/DHCP IP allocation to meet different needs. IP group will simplify the management work.
6	Set QoS bandwidth management: avoid bandwidth occupation	Restrict bandwidth and session of WAN ports, LAN IP and application.	To assure transmission of important information, manage and allocate the bandwidth further to achieve best efficiency.

7	Set Firewall: prevent attack and improper access to network resources	Block attack, Set Access rule and restrict Web access.	Administrators can block BT to avoid bandwidth occupation, and enable access rules to restrict employee accessing internet improperly or using MSN, QQ and Skype during working time. They can also protect network from Worm or ARP attacking.
8	Advanced Settings : DMZ/Forwarding, UPnP, DDNS, MAC Clone	DMZ/Forwarding, UPnP, Routing Mode, multiple WAN IP, DDNS and MAC Clone	DMZ/Forwarding, UPnP, Routing Mode, multiple WAN IP, DDNS and MAC Clone
9	Management and maintenance settings: Syslog, SNMP, and configuration backup	Monitor VPN Router working status and configuration backup.	Administrators can look up system log and monitor system status and inbound/outbound flow in real time.
10	VPN Virtual Private Network, QnoKey, QVM VPN function setting	Configure VPN tunnels, e.g. PPTP, QnoKey, and QVM VPN.	Configure different types of VPN to meet different application environment.
11	Logout	Close configuration window.	Logout VPN Router web- based UI.

We will follow the process flow to complete the network setting in the following chapters.

III. Hardware Installation

In this chapter we are going to introduce hardware interface as well as physical installation.

3.1 LED Signal

LED Signal Description

LED	Color	Description
Power	Green	Green LED on: Power ON
DIAG	Amber	Amber LED on: System self-test is running. Amber LED off: System self-test is completed successfully.
Link/Act (Green light at the right of the port)	Green	Green LED on: Ethernet connection is fine. Green LED blinking: Packets are transmitting through Ethernet port.
100M- Speed (Amber light at the left of the port)	Amber	Amber LED on: Ethernet is running at 100Mbps. Amber LED off: Ethernet is running at 10Mbps.
Connect	Green	Green LED on: WAN is connected and gets the IP address.

Reset

Action	Description
Press Reset Button For 5 Secs	Warm Start DIAG indicator: Amber LED flashing slowly.
Press Reset Button Over 10 Secs	Factory Default DIAG indicator: Amber LED flashing quickly.

System Built-in Battery

A system timing battery is built into the device. The lifespan of the battery is about 1~2 years. If the battery life is over or it can not be charged, the device will not be able to record time correctly, nor synchronize with internet NTP time server. Please contact your system supplier for information on how to replace the battery.

Attention!

Do not replace the battery yourself; otherwise irreparable damage to the product may be caused.

Installing the device on a Standard 19" Rack

We suggest to either place the device on a desk or install it in a rack with attached brackets. Do not place other heavy objects together with the device on a rack. Overloading may cause the rack to fail, thus causing damage or danger.

Each device comes with a set of rack installation accessories, including 2 L-shaped brackets and 8 screws. Users can rack-mount the device onto the chassis. Please refer to the figure below for the installation onto a 19" rack:

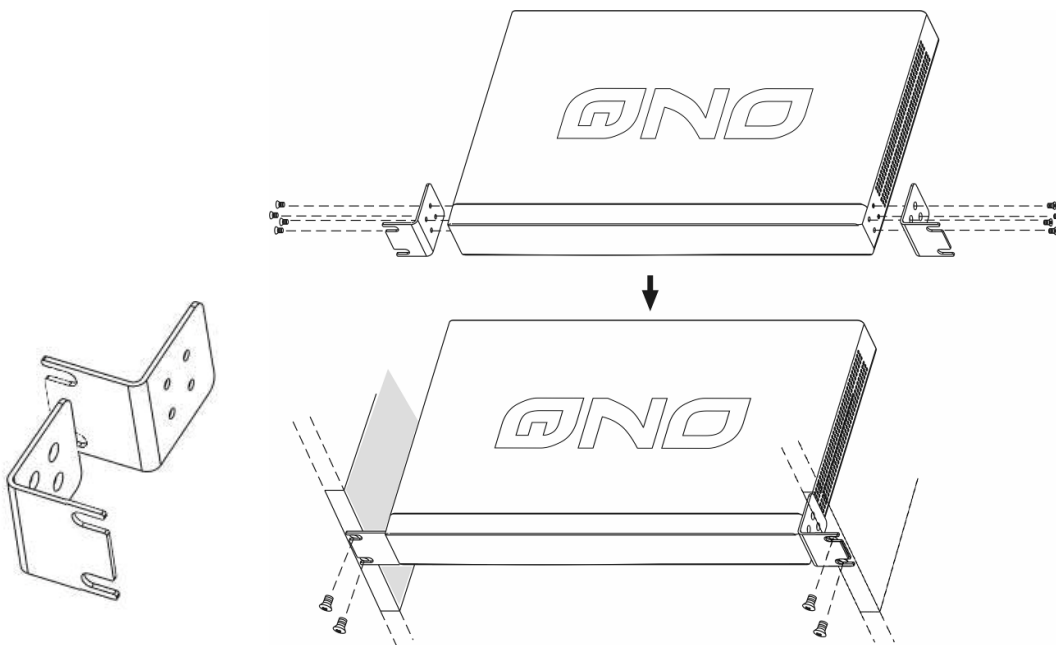

Attention!

In order for the device to run smoothly, wherever users install it, be sure not to obstruct the vent on each side of the device. Keep at least 10cm space in front of both the vents for air convection.

3.2 VPN Router Network Connection

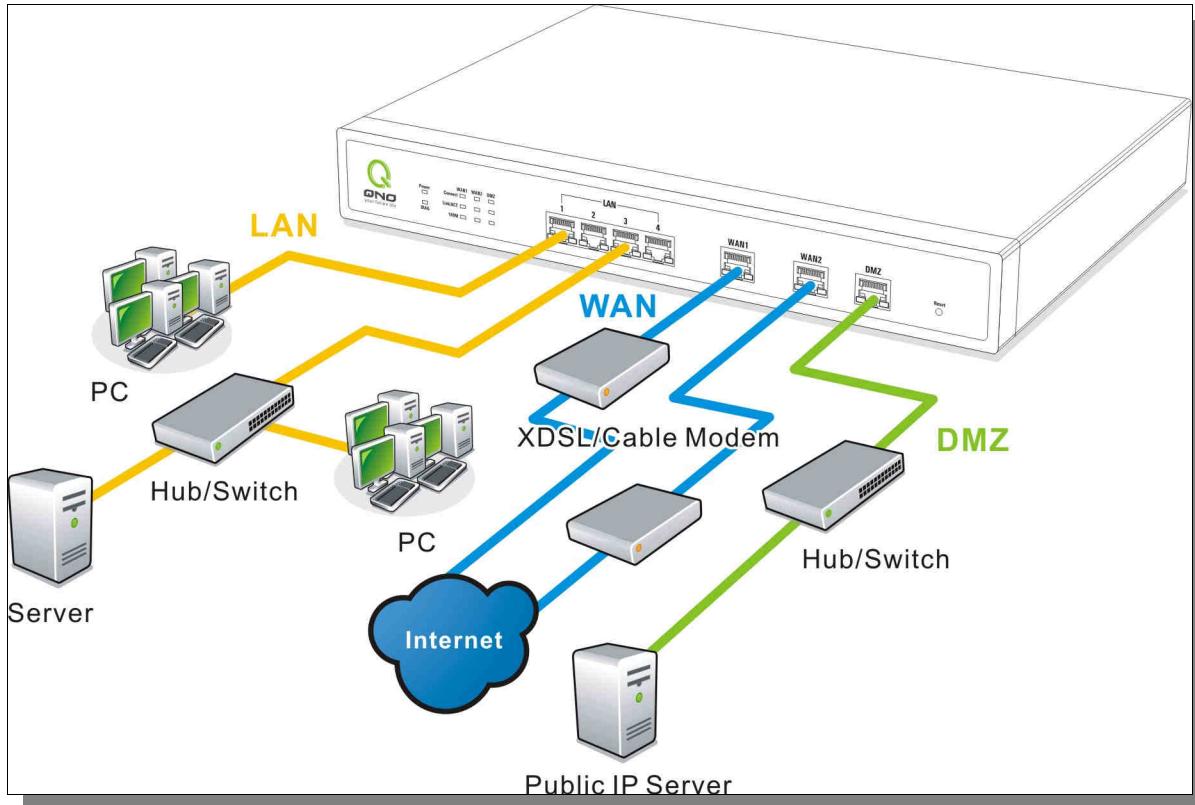

WAN connection : A WAN port can be connected with xDSL Modem, Fiber Modem, Switching Hub, or through an external router to connect to the Internet.

LAN Connection: The LAN port can be connected to a Switching Hub or directly to a PC. Users can use servers for monitoring or filtering through the port after "Physical Port Mangement" configuration is done.

DMZ : The DMZ port can be connected to servers that have legal IP addresses, such as Web servers, mail servers, etc.

IV. Login

This chapter is mainly introducing Web- based UI after connecting the device.

First, check up the device's IP address by connecting to DOS through the LAN PC under the device. Go to Start → Run, enter cmd to command DOS, and enter ipconfig for getting Default Gateway address, as the graphic below, 192.168.1.1. Make sure Default Gateway is also the default IP address of the router.

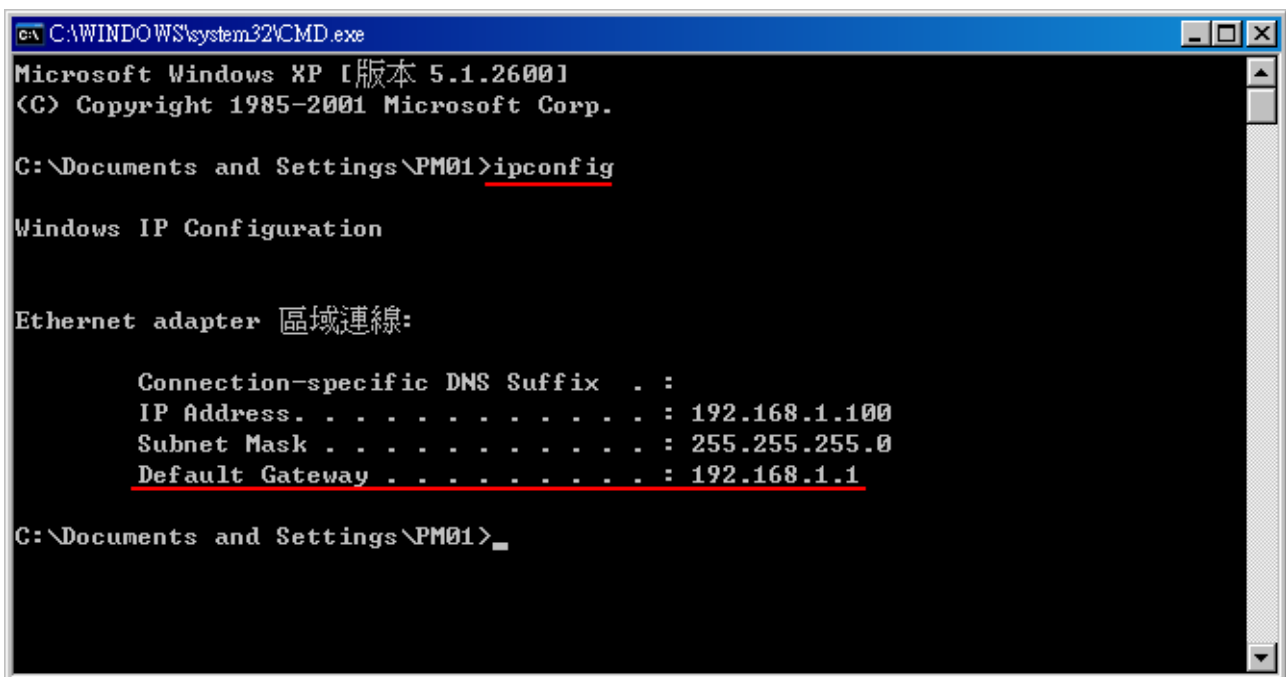

```
C:\WINDOWS\system32\CMD.exe
Microsoft Windows XP [版本 5.1.2600]
(C) Copyright 1985-2001 Microsoft Corp.

C:\Documents and Settings\PM01>ipconfig

Windows IP Configuration

Ethernet adapter 區域連線:

    Connection-specific DNS Suffix  . : 
    IP Address. . . . .                : 192.168.1.100
    Subnet Mask . . . . .              : 255.255.255.0
    Default Gateway . . . . .           : 192.168.1.1

C:\Documents and Settings\PM01>
```

Attention!

When not getting IP address and default gateway by using "ipconfig", or the received IP address is 0.0.0.0 and 169.X.X.X, we recommend that users should check if there is any problem with the circuits or the computer network card is connected nicely.

Then, open webpage browser, IE for example, and key in 192.168.1.1 in the website column. The login window will appear as below:

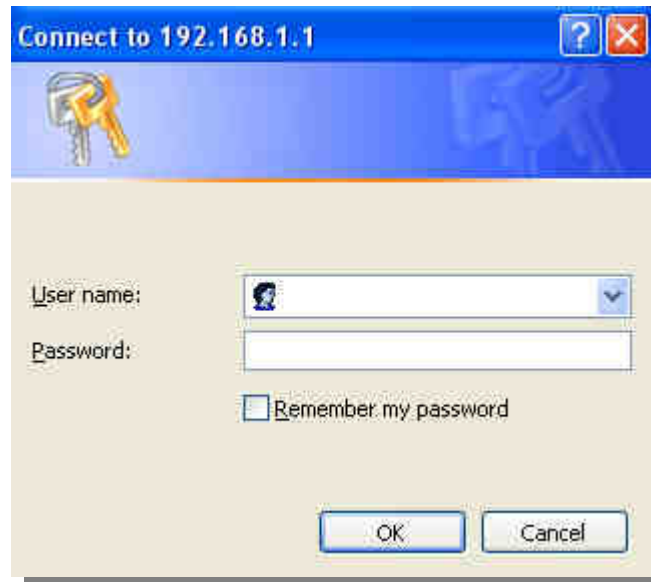

The device's default username and password are both "admin". Users can change the login password in the setting later.

Attention!

For security, we strongly suggest that users must change password after login. Please keep the password safe, or you can not login to the device. Press Reset button for more than 10 sec, all the setting will return to default.

After login, the device's web-based UI will be shown. Select the language on the upper right corner of the webpage. The language chosen will be in blue. Please select "English" as below.



V. Device Spec Verification, Status Display and Login Password and Time Setting

This chapter introduces the device specification and status after login as well as change password and system time settings for security.

5.1 Home Page

In the Home page, all the device's parameters and status are listed for users' reference.

5.1.1 WAN Status

▶ WAN Status

Interface	WAN 1	WAN 2	WAN 3	WAN 4	DMZ
IP Address	192.168.4.149	0.0.0.0	0.0.0.0	0.0.0.0	0.0.0.0
Default Gateway	192.168.4.1	0.0.0.0	0.0.0.0	0.0.0.0	0.0.0.0
DNS Server	192.168.5.21	0.0.0.0	0.0.0.0	0.0.0.0	---
Session	11	0	0	0	0
Downstream Bandwidth Usage(%)	0	0	0	0	
Upstream Bandwidth Usage(%)	0	0	0	0	
DDNS	Dyndns Disabled 3322 Disabled Dtdns Disabled Qnodns Disabled	Dyndns Disabled 3322 Disabled Dtdns Disabled Qnodns Disabled	Dyndns Disabled 3322 Disabled Dtdns Disabled Qnodns Disabled	Dyndns Disabled 3322 Disabled Dtdns Disabled Qnodns Disabled	---
Quality of Service	0 rules set	0 rules set	0 rules set	0 rules set	---
Manual Connect	Release Renew	Release Renew	Release Renew	Release Renew	---

IP Address :	Indicates the current IP configuration for WAN port.
Default Gateway :	Indicates current WAN gateway IP address from ISP.
DNS Server :	Indicates the current DNS IP configuration.
Session :	Indicates the current session number for each WAN in the device.
Downstream Bandwidth Usage(%) :	Indicates the current downstream bandwidth usage(%) for each WAN.
Upstream Bandwidth Usage(%) :	Indicates the current upstream bandwidth usage(%) for each WAN.
DDNS :	Indicates if Dynamic Domain Name is activated. The default configuration is "Off".

Quality of Service :	Indicates how many QoS rules are set.
Manual Connect :	When "Obtain an IP automatically" is selected, two buttons (Release and Renew) will appear. If a WAN connection, such as PPPoE or PPTP, is selected, "Disconnect" and "Connect" will appear.
DMZ IP Address :	Indicates the current DMZ IP address.

5.1.2 Physical Port Status

Physical Port Status

Port ID	1	2	3	4	5	6	7	8
Interface	LAN							
Status	Connect	Enabled	Enabled	Enabled	Enabled	Enabled	Enabled	Enabled

Port ID	9	10	11	12	13	14	15	DMZ
Interface	LAN			WAN 4	WAN 3	WAN 2	WAN 1	DMZ
Status	Enabled	Enabled	Enabled	Enabled	Enabled	Enabled	Connect	Enabled

The status of all system ports, including each connected and enabled port, will be shown on this Home page (see above table). Click the respective status button and a separate window will appear to show detailed data (including setting status summary and statistics) of the selected port.



The current port setting status information will be shown in the Port Information Table. Examples: type (10Base-T/100Base-TX/1000Base-T), iniferface (WAN/ LAN/ DMZ), link status (Up/ Down), physical port status (Port Enabled/ Port Disabled), priority (high or normal), speed status (10Mbps or 100Mbps), duplex status (Half/ Full), auto negotiation (Enabled or Disabled). The table also shows statistics of Receive/ Transmit Packets, Receive/Transmit Packets Byte Count as well as Error Packets Count.

5.1.3 System Information

System Information

Device IP Address/Subnet Mask	192.168.1.1/255.255.255.0	Serial Number	
Working Mode	Gateway	Firmware Version	
System Active Time	0 Days 2 Hours 8 Minutes 23 Seconds	Current Time	Mon Dec 22 2008 16:31:00

Device IP Address/ Subnet Mask : Identifies the current device IP address and subnet mask. The default is 192.168.1.1 and 255.255.255.0

Working Mode : Indicates the current working mode. Can be Gateway or Router mode. The default is "Gateway" mode.

System active time: Indicates how long the device has been running.

Serial Number: This number is the device serial number.

Firmware Version : Information about the device present software version.

Current Time: Indicates the device present time. Please note: To have the correct time, users must synchronize the device with the remote NTP server first.

5.1.4 Firewall Status

▶ FirewallStatus

Firewall	Status
SPI (Stateful Packet Inspection)	On
DoS (Denial of Service)	On
Block WAN Request	Off
Prevent ARP Virus Attack	Off
Remote Management	Off
Access Rule	12 rules set

SPI (Stateful Packet Inspection) : Indicates whether SPI (Stateful Packet Inspection) is on or off. The default configuration is "On".

DoS (Denial of Service) : Indicates if DoS attack prevention is activated. The default configuration is "On".

Block WAN Request : Indicates that denying the connection from Internet is activated. The default configuration is "On".

Prevent ARP Virus Attack : Indicates that preventing Arp virus attack is activated. The default configuration is "Off".

Remote Management: Indicates if remote management is activated (on or off). Click the hyperlink to enter and manage the configuration. The default configuration is "Off".

Access Rule : Indicates the number of access rule applied in the device.

5.1.5 VPN Status

▶ VPN Status

VPN Setting	Status
Tunnel(s) Used	0
Tunnel(s) Available	150
PPTP Server	Disabled

VPN Setting Status : Indicates VPN setting information in the device.

Tunnel(s) Used : Indicates number of tunnels that have been configured in VPN (Virtual Private Network).

Tunnel(s) Available : Indicates number of tunnels that are available for VPN (Virtual Private Network).

PPTP Server : Indicates if PPTP server is enabled.

5.1.6 Log Setting Status

▶ Log Setting Status

Syslog Server	Disabled
E-mail Alert	Disabled

Syslog Server :	Indicates if Syslog Server is Enabled or Disabled.
E-mail Alert :	Indicates if Email Alert is Enabled or Disabled.

5.2 Change and Set Login Password and Time

5.2.1 Password Setting

When you login the device setting window every time, you must enter the password. The default value for the device username and password are both "admin". For security reasons, we strongly recommend that you must change your password after first login. Please keep the password safe, or you might not login to the device. You can press Reset button for more than 10 sec, the device will return back to default.

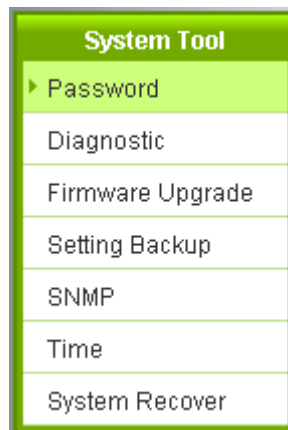

▶ Password

User Name :	admin
Old Password :	<input type="text"/>
New User Name :	Qno
New Password :	<input type="text"/>
Confirm New Password :	<input type="text"/>

Apply Cancel

User Name :	The default is "admin".
Old Password :	Input the original password. (The default is "admin".)
New User Name :	Input the new user name. i.e.Qno
New Password :	Input the new password.

Confirm New Password :	Input the new password again for verification.
Apply :	Click " Apply " to save the configuration.
Cancel :	Click " Cancel " to leave without making any change. This action will be effective before "Apply" to save the configuration.

5.2.2 Time

The device can adjust time setting. Users can know the exact time of event occurrences that are recorded in the System Log, and the time of closing or opening access for Internet resources. You can either select the embedded NTP Server synchronization function or set up a time reference.

Synchronize with external NTP server : The device has embedded NTP server, which will update the time spontaneously.

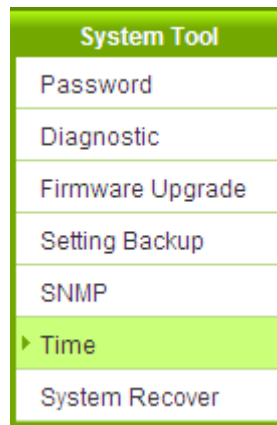

- Set the local time using Network Time Protocol (NTP) automatically
- Set the local time Manually

Time Zone :	Hong Kong (GMT+08:00) 
Daylight Saving :	<input type="checkbox"/> Enabled from 3 Month 28 Day to 10 Month 28 Day
External NTP Server :	<input type="text"/>

Time Zone :	Select your location from the pull-down time zone list to show correct local time.
Daylight Saving :	If there is Daylight Saving Time in your area, input the date range. The device will adjust the time for the Daylight Saving period automatically.
External NTP Server :	If you have your own preferred time server, input the server IP address.
Apply :	After the changes are completed, click "Apply" to save the configuration.
Cancel :	Click "Cancel" to leave without making any change. This action will be effective before "Apply" to save the configuration.

Select the Local Time Manually: Input the correct time, date, and year in the boxes.

- Set the local time using Network Time Protocol (NTP) automatically
- Set the local time Manually

17 Hours 25 minutes 27 Seconds
9 Month 4 Day 2008 Year

Apply Cancel

After the changes are completed, click **"Apply"** to save the configuration. Click **"Cancel"** to leave without making any change. This action will be effective before "Apply" to save the configuration.

VI. Network

This Network page contains the basic settings. For most users, completing this general setting is enough for connecting with the Internet. However, some users need advanced information from their ISP. Please refer to the following descriptions for specific configurations.

6.1 Network Connection

Host Name :	<input type="text" value="4_WAN_QVM_Router"/>	(Required by some ISPs)
Domain Name :	<input type="text" value="4_WAN_QVM_Router"/>	(Required by some ISPs)

LAN Setting

MAC Address :	<input type="text" value="08"/> <input type="text" value="-3b"/> <input type="text" value="-ba"/> <input type="text" value="-8a"/> <input type="text" value="-67"/> <input type="text" value="-b9"/>	(Default: 08-3b-ba-8a-67-b9)
Device IP Address :	<input type="text" value="192"/> <input type="text" value="168"/> <input type="text" value="1"/> <input type="text" value="1"/>	
Subnet Mask :	<input type="text" value="255"/> <input type="text" value="255"/> <input type="text" value="255"/> <input type="text" value="0"/>	

Multiple Subnet Setting	
<input type="button" value="Add/Edit"/>	
No.	Subnet

WAN Setting

Please choose how many WAN ports you prefer to use : (Default: 4)

Interface	Connection Type	Config.
WAN 1	Obtain an IP automatically	Edit
WAN 2	Obtain an IP automatically	Edit
WAN 3	Obtain an IP automatically	Edit
WAN 4	Obtain an IP automatically	Edit

DMZ Setting

Interface	IP Address	Config.
DMZ	0.0.0.0	Edit

6.1.1 Host Name and Domain Name

Host Name :	<input type="text"/>	(Required by some ISPs)
Domain Name :	<input type="text"/>	(Required by some ISPs)

Device name and domain name can be input in the two boxes. Though this configuration is not necessary in most environments, some ISPs in some countries may require it.

6.1.2 LAN Setting

This is configuration information for the device current LAN IP address. The default configuration is 192.168.1.1 and the default Subnet Mask is 255.255.255.0. It can be changed according to the actual network structure.

▶ LAN Setting

MAC Address :	<input type="text" value="26"/> <input type="text" value="-"/> <input type="text" value="7a"/> <input type="text" value="-"/> <input type="text" value="eb"/> <input type="text" value="-"/> <input type="text" value="6c"/> <input type="text" value="-"/> <input type="text" value="30"/> <input type="text" value="-"/> <input type="text" value="4a"/>
	(Default: 26-7a-eb-6c-30-4a)
Device IP Address :	<input type="text" value="192"/> <input type="text" value="."/> <input type="text" value="168"/> <input type="text" value="."/> <input type="text" value="1"/> <input type="text" value="."/> <input type="text" value="1"/>
Subnet Mask :	<input type="text" value="255"/> <input type="text" value="."/> <input type="text" value="255"/> <input type="text" value="."/> <input type="text" value="255"/> <input type="text" value="."/> <input type="text" value="0"/>

Multiple Subnet Setting	
<input type="button" value="Add/Edit"/>	
No.	Subnet

Multiple-Subnet Setting :

Click "Add/Edit" to enter the configuration page, as shown in the following figure. Input the respective IP addresses and subnet masks.

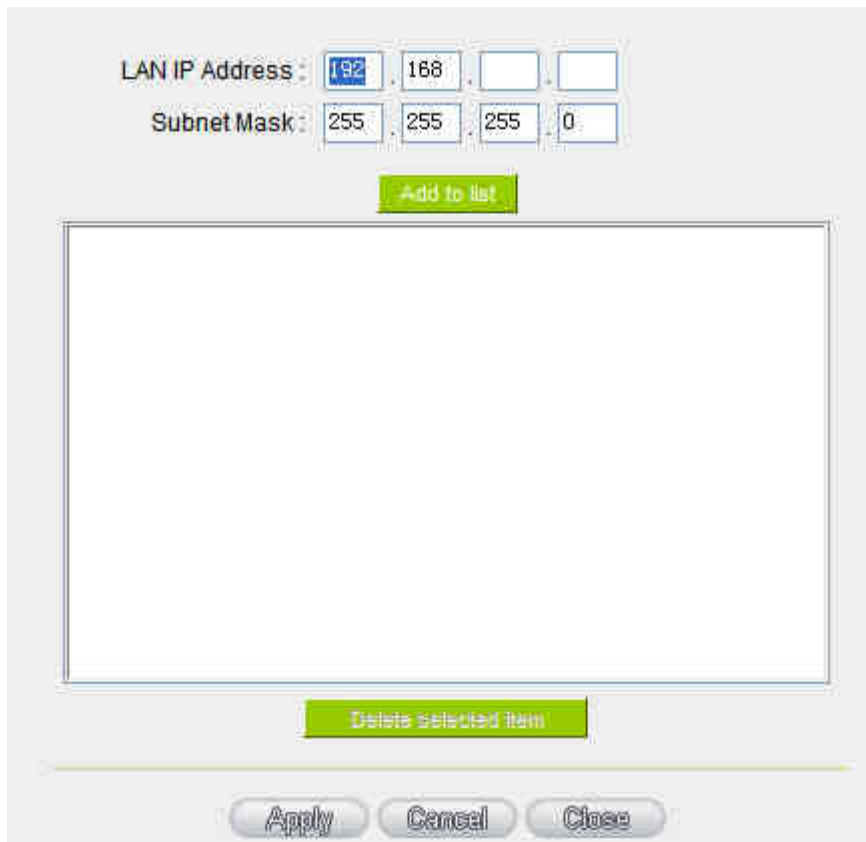

This function enables users to input IP segments that differ from the router network segment to the multi-net segment configuration; the Internet will then be directly accessible. In other words, if there are already different IP segment groups in the Intranet, the Internet is still accessible without making any changes to internal PCs. Users can make changes according to their actual network structure.

6.1.3 WAN & DMZ Settings

WAN Setting :

▶ WAN Setting

Please choose how many WAN ports you prefer to use : (Default: 4)

Interface	Connection Type	Config.
WAN 1	Obtain an IP automatically	Edit
WAN 2	Obtain an IP automatically	Edit
WAN 3	Obtain an IP automatically	Edit
WAN 4	Obtain an IP automatically	Edit

Interface: An indication of which port is connected.

Connection Type: Obtain an IP automatically, Static IP connection, PPPoE (Point-to-Point Protocol over Ethernet), PPTP (Point-to-Point Tunneling Protocol) or Transparent Bridge.

Config.: A modification in an advanced configuration: Click Edit to enter the advanced configuration page.

Obtain an Automatic IP automatically:

This mode is often used in the connection mode to obtain an automatic DHCP IP. This is the device system default connection mode. It is a connection mode in which DHCP clients obtain an IP address automatically. If having a different connection mode, please refer to the following introduction for selection of appropriate configurations. Users can also set up their own DNS IP address. Check the options and input the user-defined DNS IP addresses.

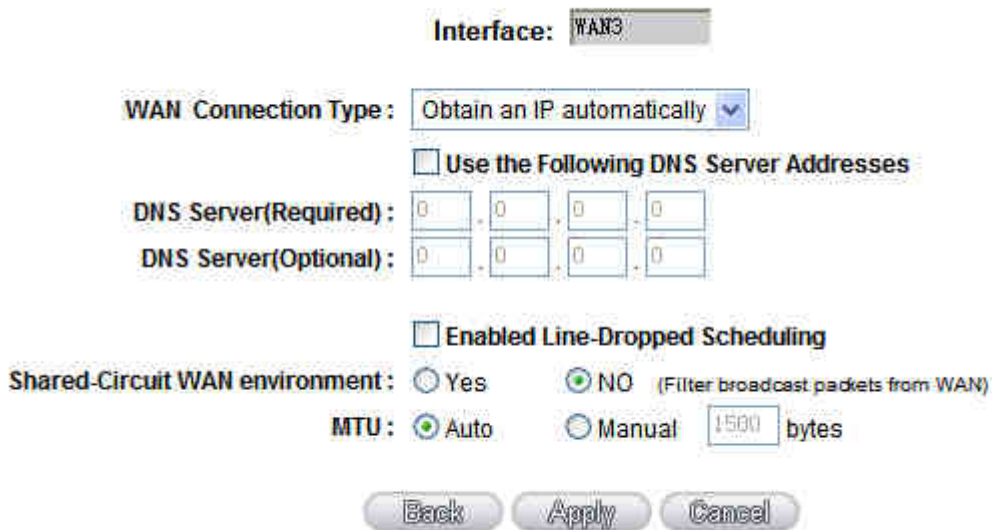

Interface:

WAN Connection Type:

Use the Following DNS Server Addresses

DNS Server(Required): . . .

DNS Server(Optional): . . .

Enabled Line-Dropped Scheduling

Shared-Circuit WAN environment: Yes NO (Filter broadcast packets from WAN)

MTU: Auto Manual bytes

Use the following DNS Server Addresses:	Select a user-defined DNS server IP address.
DNS Server:	Input the DNS IP address set by ISP. At least one IP group should be input. The maximum acceptable groups is two IP groups.

Enable Line-Dropped Scheduling:	The WAN disconnection schedule will be activated by checking this option. In some areas, there is a time limitation for WAN connection service. For example: the optical fiber service will be disconnected from 0:00 am to 6:00 am. Although there is a standby system in the device, at the moment of WAN disconnection, all the external connections that go through this WAN will be disconnected too. Only after the disconnected lines are reconnected can they go through the standby system to connect with the Internet. Therefore, to avoid a huge number of disconnection, users can activate this function to arrange new connections to be made through another WAN to the Internet. In this way, the effect of any disconnection can be minimized.
Line-Dropped Period	Input the time rule for disconnection of this WAN service.
Line-Dropped Scheduling	Input how long the WAN service may be disconnected before the newly added connections should go through another WAN to connect with the Internet.
Link Backup Interface	Select another WAN port as link backup when port binding is configured. Users should select the port that employs the same ISP.
Shared- Circuit WAN environment	If your WAN connects to a Switch, select "Enabled" to filter broadcast packets. The default is "Disabled".
MTU :	MTU is abbreviation of Maximum Transmission Unit. "Auto" and "Manual" can be chosen. The default value is 1500. Different value could be set in different network environment. (e.g. ADSL PPPoE MTU: 1492) The default is "Auto".

After the changes are completed, click **"Apply"** to save the configuration, or click **"Cancel"** to leave without making any changes.

Static IP

If an ISP issues a static IP (such as one IP or eight IP addresses, etc.), please select this connection mode and follow the steps below to input the IP numbers issued by an ISP into the relevant boxes.

Interface:

WAN Connection Type:

WAN IP Address:

Subnet Mask:

Default Gateway:

DNS Server(Required):

DNS Server(Optional):

Enabled Line-Dropped Scheduling

Shared-Circuit WAN environment: Yes NO (Filter broadcast packets from WAN)

MTU: Auto Manual bytes

WAN IP address:	Input the available static IP address issued by ISP.
Subnet Mask:	Input the subnet mask of the static IP address issued by ISP, such as: Issued eight static IP addresses: 255.255.255.248 Issued 16 static IP addresses: 255.255.255.240
Default Gateway:	Input the default gateway issued by ISP. For ADSL users, it is usually an ATU-R IP address. As for optical fiber users, please input the optical fiber switching IP.
DNS Server:	Input the DNS IP address issued by ISP. At least one IP group should be input. The maximum acceptable is two IP groups.
WAN IP address:	Input the available static IP address issued by ISP.

<p>Enable Line-Dropped Scheduling:</p>	<p>The WAN disconnection schedule will be activated by checking this option. In some areas, there is a time limitation for WAN connection service. For example: the optical fiber service will be disconnected from 0:00 am to 6:00 am. Although there is a standby system in the device, at the moment of WAN disconnection, all the external connections that go through this WAN will be disconnected too. Only after the disconnected lines are reconnected can they go through the standby system to connect with the Internet. Therefore, to avoid a huge number of disconnections, users can activate this function to arrange new connections to be made through another WAN to the Internet. In this way, the effect of any disconnection can be minimized.</p>
<p>Line-Dropped Period</p>	<p>Input the time rule for the disconnection of this WAN service.</p>
<p>Line-Dropped Scheduling</p>	<p>Input how long the WAN service may be disconnected before the newly added connections should go through another WAN to connect with the Internet.</p>
<p>WAN IP address:</p>	<p>Input the available static IP address issued by ISP.</p>
<p>Shared- Circuit WAN environment</p>	<p>If your WAN connects to a Switch, select "Enabled" to filter broadcast packets. The default is "Disabled".</p>

After the changes are completed, click **"Apply"** to save the configuration, or click **"Cancel"** to leave without making any changes.

PPPoE

This option is for an ADSL virtual dial-up connection (suitable for ADSL PPPoE). Input the user connection name and password issued by ISP. Then use the PPP Over-Ethernet software built into the device to connect with the Internet. If the PC has been installed with the PPPoE dialing software provided by ISP, remove it. This software will no longer be used for network connection.

Interface: WAN3

WAN Connection Type: PPPoE

User Name:

Password:

Connect on Demand: Max Idle Time Min.

Keep Alive: Redial Period Sec.

Enabled Line-Dropped Scheduling

Shared-Circuit WAN environment: Yes NO (Filter broadcast packets from WAN)

MTU: Auto Manual bytes

User Name:	Input the user name issued by ISP.
Password	Input the password issued by ISP.
Connect on Demand:	This function enables the auto-dialing function to be used in a PPPoE dial connection. When the client port attempts to connect with the Internet, the device will automatically make a dial connection. If the line has been idle for a period of time, the system will break the connection automatically. (The default time for automatic break-off resulting from no packet transmissions is five minutes).
Keep Alive:	This function enables the PPPoE dial connection to keep connected, and to automatically redial if the line is disconnected. It also enables a user to set up a time for redialing. The default is 30 seconds.

<p>Enable Line-Dropped Scheduling</p>	<p>The WAN disconnection schedule will be activated by checking this option. In some areas, there is a time limitation for WAN connection service. For example: the optical fiber service will be disconnected from 0:00 am to 6:00 am. Although there is a standby system in the device, at the moment of WAN disconnection, all the external connections that go through this WAN will be disconnected too. Only after the disconnected lines are reconnected can they go through the standby system to connect with the Internet. Therefore, to avoid a huge number of disconnections, users can activate this function to arrange new connections through another WAN to the Internet. In this way, the effect of any disconnection can be minimized.</p>
<p>Line-Dropped Period</p>	<p>Input the time rule for the disconnection of this WAN service.</p>
<p>Line-Dropped Scheduling</p>	<p>Input how long the WAN service may be disconnected before the newly added connections should go through another WAN to connect with the Internet.</p>
<p>Link Backup Interface</p>	<p>Select another WAN port as link backup when port binding is configured. Users should select the port that employs the same ISP.</p>
<p>Shared- Circuit WAN environment</p>	<p>If your WAN connects to a Switch, select "Enabled" to filter broadcast packets. The default is "Disabled".</p>
<p>MTU :</p>	<p>MTU is abbreviation of Maximum Transmission Unit. "Auto" and "Manual" can be chosen. The default value is 1500. Different value could be set in different network environment. (e.g. ADSL PPPoE MTU: 1492) The default is "Auto".</p>

After the changes are completed, click **"Apply"** to save the configuration, or click **"Cancel"** to leave without making any change.

PPTP

This option is for the PPTP time counting system. Input the user's connection name and

password issued by ISP, and use the built-in PPTP software to connect with the Internet.

Interface: WAN3

WAN Connection Type: PPTP

WAN IP Address: 0 . 0 . 0 . 0

Subnet Mask: 0 . 0 . 0 . 0

Default Gateway: 0 . 0 . 0 . 0

User Name:

Password:

Connect on Demand: Max Idle Time 5 **Min.**

Keep Alive: Redial Period 30 **Sec.**

Enabled Line-Dropped Scheduling

Shared-Circuit WAN environment: Yes NO (Filter broadcast packets from WAN)

MTU: Auto Manual 1500 bytes

WAN IP Address:	This option is to configure a static IP address. The IP address to be configured could be one issued by ISP. (The IP address is usually provided by the ISP when the PC is installed. Contact ISP for relevant information).
Subnet Mask:	Input the subnet mask of the static IP address issued by ISP, such as: Issued eight static IP addresses: 255.255.255.248 Issued 16 static IP addresses: 255.255.255.240
Default Gateway Address:	Input the default gateway of the static IP address issued by ISP. For ADSL users, it is usually an ATU-R IP address.
User Name:	Input the user name issued by ISP.
Password:	Input the password issued by ISP.

<p>Connect on Demand:</p>	<p>This function enables the auto-dialing function to be used for a PPTP dial connection. When the client port attempts to connect with the Internet, the device will automatically connect with the default ISP auto dial connection; when the network has been idle for a period of time, the system will break the connection automatically. (The default time for automatic break off when no packets have been transmitted is five minutes).</p>
<p>Keep Alive:</p>	<p>This function enables the PPTP dial connection to redial automatically when the connection has been disconnected. Users can set up the redialing time. The default is 30 seconds.</p>
<p>Enable Line-Dropped Scheduling</p>	<p>The WAN disconnection schedule will be activated by checking this option. In some areas, there is a time limitation for WAN connection service. For example: the optical fiber service will be disconnected from 0:00 am to 6:00 am. Although there is a standby system in the device, at the moment of WAN disconnection, all the external connections that go through this WAN will be disconnected too. Only after the disconnected lines are reconnected can they go through the standby system to connect with the Internet. Therefore, to avoid a huge number of disconnection, users can activate this function to arrange new connections to be made through another WAN to the Internet. In this way, the effect of any disconnection can be minimized.</p>
<p>Line-Dropped Period</p>	<p>Input the time rule for the disconnection of this WAN service.</p>
<p>Line-Dropped Scheduling</p>	<p>Input how long the WAN service may be disconnected before the newly added connections should go through another WAN to connect with the Internet.</p>
<p>Link Backup Interface</p>	<p>Select another WAN port as link backup when port binding is configured. Users should select the port that employs the same ISP.</p>

Shared- Circuit WAN environment	If your WAN connects to a Switch, select "Enabled" to filter broadcast packets. The default is "Disabled".
MTU :	MTU is abbreviation of Maximum Transmission Unit. "Auto" and "Manual" can be chosen. The default value is 1500. Different value could be set in different network environment. (e.g. ADSL PPPoE MTU: 1492) The default is "Auto".

After the changes are completed, click **"Apply"** to save the configuration, or click **"Cancel"** to leave without making any changes.

Transparent Bridge

If all Intranet IP addresses are applied as Internet IP addresses, and users don't want to substitute private network IP addresses for all Intranet IP addresses (ex. 192.168.1.X), this function will enable users to integrate existing networks without changing the original structure. Select the Transparent Bridge mode for the WAN connection mode. In this way, users will be able to connect normally with the Internet while keeping the original Internet IP addresses in Intranet IP configuration.

If there are two WANs configured, users still can select Transparent Bridge mode for WAN connection mode, and load balancing will be achieved as usual.

Interface: WAN3

WAN Connection Type: Transparent Bridge

WAN IP Address: 0 . 0 . 0 . 0

Subnet Mask: 0 . 0 . 0 . 0

Default Gateway: 0 . 0 . 0 . 0

DNS Server(Required): 0 . 0 . 0 . 0

DNS Server(Optional): 0 . 0 . 0 . 0

LAN (Public) IP Range 1: 0 . 0 . 0 . 0 to 0 . 0 . 0 . 0

LAN (Public) IP Range 2: 0 . 0 . 0 . 0 to 0 . 0 . 0 . 0

Enabled Line-Dropped Scheduling

Shared-Circuit WAN environment: Yes NO (Filter broadcast packets from WAN)

MTU: Auto Manual 1500 bytes

Back Apply Cancel

WAN IP Address:	Input one of the static IP addresses issued by ISP.
Subnet Mask :	Input the subnet mask of the static IP address issued by ISP, such as: Issued eight static IP addresses: 255.255.255.248 Issued 16 static IP addresses: 255.255.255.240
Default Gateway Address:	Input the default gateway of the static IP address issued by ISP. For ADSL users, it is usually an ATU-R IP address.
DNS Server :	Input the DNS IP address set by ISP. At least one IP group should be input. The maximum acceptable is two IP groups.
Internal LAN IP Range :	Input the available IP range issued by ISP. If ISP issued two discontinuous IP address ranges, users can input them into Internal LAN IP Range 1 and Internal LAN IP Range 2 respectively.

Enable Line-Dropped Scheduling :	The WAN disconnection schedule will be activated by checking this option. In some areas, there is a time limitation for WAN connection service. For example: the optical fiber service will be disconnected from 0:00 am to 6:00 am. Although there is a standby system in the device, at the moment of WAN disconnection, all the external connections that go through this WAN will be disconnected too. Only after the disconnected lines are reconnected can they go through the standby system to connect with the Internet. Therefore, to avoid a huge number of disconnections, users can activate this function to arrange new connections through another WAN to the Internet. In this way, the effect of any disconnection can be minimized.
Line-Dropped Period :	Input the time rule for the disconnection of this WAN service.
Line-Dropped Scheduling :	Input how long the WAN service may be disconnected before the newly added connections should go through another WAN to connect with the Internet.
Link Backup Interface :	Select another WAN port as link backup when port binding is configured. Users should select the port that employs the same ISP.
Shared- Circuit WAN environment :	If your WAN connects to a Switch, select "Enabled" to filter broadcast packets. The default is "Disabled".
MTU :	MTU is abbreviation of Maximum Transmission Unit. "Auto" and "Manual" can be chosen. The default value is 1500. Different value could be set in different network environment. (e.g. ADSL PPPoE MTU: 1492) The default is "Auto".

After the changes are completed, click **"Apply"** to save the configuration, or click **"Cancel"** to leave without making any changes.

DMZ Setting

For some network environments, an independent DMZ port may be required to set up

externally connected servers such as WEB and Mail servers. Therefore, the device supports a set of independent DMZ ports for users to set up connections for servers with real IP addresses. The DMZ ports act as bridges between the Internet and LANs.

DMZ Setting

Interface	IP Address	Config.
DMZ	0.0.0.0	Edit

IP address: Indicates the current default static IP address.

Config.: Indicates an advanced configuration modification: Click **Edit** to enter the advanced configuration page.

The DMZ configuration can be classified by Subnet and Range:

Subnet :

The DMZ and WAN located in different Subnets

For example: If the ISP issued 16 real IP addresses: 220.243.230.1-16 with Mask 255.255.255.240, users have to separate the 16 IP addresses into two groups: 220.243.230.1-8 with Mask 255.255.255.248, and 220.243.230.9-16 with Mask 255.255.255.248 and then set the device and the gateway in the same group with the other group in the DMZ.

Interface:

Subnet
 Range (DMZ & WAN within same subnet)

DMZ IP Address : . . .

Subnet Mask : . . .

Range :

DMZ and WAN within same Subnet

Interface:

Subnet Range (DMZ & WAN within same subnet)

Interface :

IP Range : . . . to

IP Range: Input the IP range located at the DMZ port.

After the changes are completed, click **"Apply"** to save the configuration, or click **"Cancel"** to leave without making any changes.

6.2 Multi- WAN Setting

6.2.1 Load Balance Mode

Mode

Auto Load Balance Mode :	<input checked="" type="radio"/> By Session	<input type="radio"/> By IP
Exculsive Mode : (Remaining WAN Balance)	<input type="radio"/> By Session	<input type="radio"/> By IP
Strategy Routing Mode :	<input type="radio"/> By Session	<input type="radio"/> By IP
<div style="background-color: #92d050; padding: 2px; display: inline-block;">Set WAN Grouping</div>		
China Netcom :	Disabled	<div style="background-color: #92d050; padding: 2px; display: inline-block;">Import Strategy</div>
Self-defined Strategy1 :	Disabled	
Self-defined Strategy2 :	Disabled	

Auto Load Balance Mode

When Auto Load Balance mode is selected, the device will use sessions or IP and the WAN bandwidth automatically allocate connections to achieve load balancing for external connections. The network bandwidth is set by what users input for it. For example, if the upload bandwidth of both WANs is 512Kbit/sec, the automatic load ratio will be 1:1; if one of the upload bandwidths is 1024Kbit/sec while the other is 512Kbit/sec, the automatic load ratio will be 2:1. Therefore, to ensure that the device can balance the actual network load, please input real upload and download bandwidths.

- **Session Balance:** If "By Session" is selected, the WAN bandwidth will automatically allocate connections based on session number to achieve network load balance.
- **IP Session Balance:** If "By IP" is selected, the WAN bandwidth will automatically allocate connections based on IP amount to achieve network load balance.

Note!

For either session balancing or IP connection balancing, collocation with Protocol Binding will provide a more flexible application for bandwidth. Users can assign a specific Intranet IP to go through a specific service provider for connection, or assign an IP for a specific destination to go through the WAN users assign to connect with the Internet.

For example, if users want to assign IP 192.168.1.100 to go through WAN 1 when connecting with the Internet, or assign all Intranet IP to go through WAN 2 when connecting with servers with port 80, or assign all Intranet IP to go through WAN 1 when connecting with IP 211.1.1.1, users can do that by configuring "Protocol Binding".

Attention! When the Auto Load Balance mode is collocated with Protocol Binding, only IP addresses or servers that are configured in the connection rule will follow the rule for external connections; those which are not configured in the rule will still follow the device Auto Load Balance system.

Please refer to the explanations in **6.2.3 Configuring Protocol Binding** for setting up Protocol Binding and for examples of collocating router modes with Protocol Binding.

Exclusive Mode

This mode enables users to assign specific intranet IP addresses, destination application service ports or destination IP addresses to go through an assigned WAN for external connection. After being assigned, the specific WAN will only support those assigned Intranet IP addresses, specific destination application service ports, or specific destination IP addresses. Intranet IP, specific destination application service ports and specific destination IP that is not configured under the rules will go through other WANs for external connection. For unassigned WANs, users can select Load Balance mode and select session or IP for load balancing.

- **Session Balance:** If "By Session" is selected, the WAN bandwidth will automatically allocate connections based on session number to achieve network load balance.
- **IP Balance:** If "By IP" is selected, the WAN bandwidth will automatically allocate connections based on the number of IP addresses to achieve network load balance.

Note!

Only when a device assignment is collocated with Protocol Binding can the balancing function be brought into full play. For example, an assignment requiring all Intranet IP addresses to go through WAN 1 when connecting with service port 80, or go through WAN 1 when connecting with IP 211.1.1.1, must be set up in the Protocol Binding Configuration.

Attention: When assigning mode is selected, as in the above example, the IP(s) or service provider(s) configured in the connection rule will follow the rule for external connections, but those which are not configured in the rule will still follow the device Load Balance system to go through other WAN ports to connect with the Internet.

Please refer to the explanations in **6.2.3 Configuring Protocol Binding** for setting up Protocol Binding and for examples of collocating router mode with Protocol Binding.

Strategy Routing Mode

If strategy Routing is selected, the device will automatically allocate external connections based on routing policy (Division of traffic between Telecom and Netcom is to be used in China) embedded in the device. All you have to do is to select the WAN (or WAN group) which is connected with Netcom; the device will then automatically dispatch the traffic for Netcom through that WAN to connect with the Internet and dispatch traffic for Telecom to go through the WAN connected with Telecom to the Internet accordingly. In this way, the traffic for Netcom and Telecom can be divided.

Set WAN Grouping:

If more than one WAN is connected with Netcom, to apply a similar division of traffic policy to these WANs, a combination for the WANs must be made. Click "Set WAN Grouping"; an interactive window as shown in the figure below will be displayed.

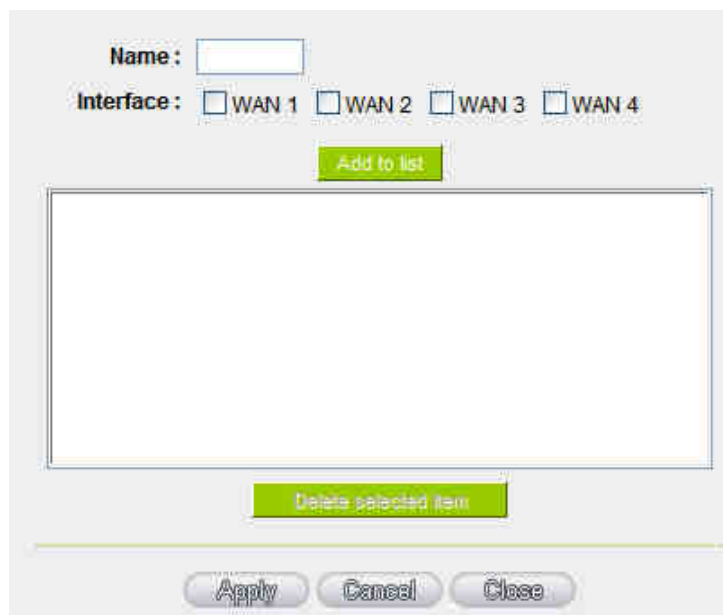

Name:

Interface: WAN 1 WAN 2 WAN 3 WAN 4

Name:	To define a name for the WAN grouping in the box, such as "Education" etc. The name is for recognizing different WAN groups.
Interface:	Check the boxes for the WANs to be added into this combination.
Add To List:	To add a WAN group to the grouping list.
Delete selected Item:	To remove selected WANs from the WAN grouping.
Apply:	Click "Apply" to save the modification.
Close:	Click "Cancel" to cancel the modification. This only works before "Apply" is clicked.

After the configuration is completed, in the China Netcom Policy window users can select WANs in combination to connect with Netcom.

Import Strategy:

A division of traffic policy can be defined by users too. In the "Import Strategy" window, select the WAN or WAN group (ex. WAN 1) to be assigned and click the "Import IP Range" button; the dialogue box for document importation will be displayed accordingly. A policy document is an editable text document. It may contain a destination IP users designated. After the path for document importation has been selected, click "Import", and then at the bottom of the configuration window click "Apply". The device will then dispatch the traffic to the assigned destination IP through the WAN (ex. WAN 1) or WAN grouping users designated to the Internet.



To build a policy document users can use a text-based editor, such as Notepad, which is included with Windows system. Follow the text format in the figure below to key in the destination IP addresses users want to assign. For example, if the destination IP address range users want to designate is 140.115.1.1 ~ 140.115.1.255, key in 140.115.1.1 ~ 140.115.1.255 in Notepad. The next destination IP address range should be keyed in the next line. Attention! Even if only one destination IP address is to be assigned, it should follow the same format. For example, if the destination IP address is 210.66.161.54, it should be keyed in as 210.66.161.54~210.66.161.54. After the document has been saved (the extension file name is .txt), users can import the IP range of self-defined strategy.

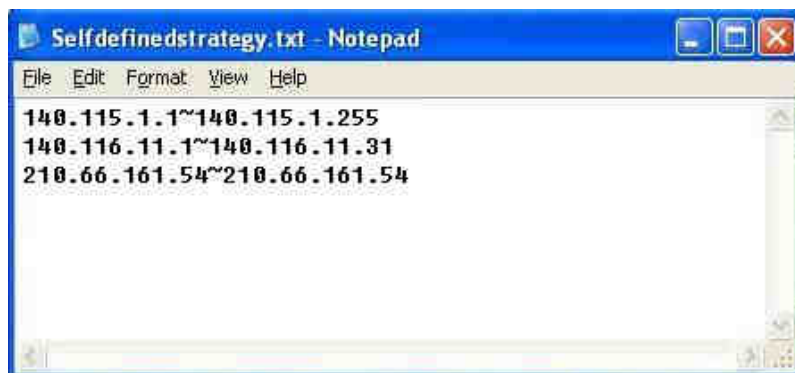

Note!

China Netcom strategy and self-defined strategy can coexist. However, if a destination IP is assigned by both China Netcom strategy and self-defined strategy, China Netcom strategy will take priority. In other words, traffic to that destination IP will be transmitted through the WAN (or WAN group) under China Netcom strategy.

6.2.2 Network Detection Service

This is a detection system for network external services. If this option is selected, information such "**Retry**" or "**Retry Timeout**" will be displayed. If two WANs are used for external connection, be sure to activate the NSD system, so as to avoid any unwanted break caused by the device misjudgment of the overload traffic for the WAN.

Network Service Detection

Interface : WAN1

<input checked="" type="checkbox"/>	Enabled	
Retry	<input type="text" value="5"/>	times
Retry timeout	<input type="text" value="30"/>	Seconds
When Fail	Keep System Log and Remove the Connection	
<input checked="" type="checkbox"/>	When In or	Out bandwidth is over <input type="text" value="2"/> % regarded as normal.
<input checked="" type="checkbox"/>	Default Gateway	
<input type="checkbox"/>	ISP Host :	<input style="width: 100%;" type="text"/>
<input type="checkbox"/>	Remote Host :	<input style="width: 100%;" type="text"/>
<input type="checkbox"/>	DNS Lookup Host :	<input style="width: 100%;" type="text"/>

Apply
Cancel

Interface:	Select the WAN Port that enables Network Service Detection.
Retry:	This selects the retry times for network service detection. The default is five times. If there is no feedback from the Internet in the configured "Retry Times", it will be judged as "External Connection Disconnected".
Retry Timeout:	Delay time for external connection detection latency. The default is 30 seconds. After the retry timeout, external service detection will restart.
When Fail:	<p>(1) Generate the Error Condition in the System Log: If an ISP connection failure is detected, an error message will be recorded in the System Log. This line will not be removed; therefore, the some of the users on this line will not have normal connections.</p> <p>This option is suitable under the condition that one of the WAN connections has failed; the traffic going through this WAN to the destination IP cannot shift to another WAN to reach the destination. For example, if users want the traffic to 10.0.0.1 ~ 10.254.254.254 to go only through WAN1, while WAN2 is not to support these destinations, users should select this option. When the WAN1 connection is disconnected, packets</p>

	<p>for 10.0.0.1~10.254.254.254 cannot be transmitted through WAN 2, and there is no need to remove the connection when WAN 1 is disconnected.</p> <p>(2) Keep System Log and Remove the Connection: If an ISP connection failure is detected, no error message will be recorded in the System Log. The packet transmitted through this WAN will be shifted to the other WAN automatically, and be shifted back again when the connection for the original WAN is repaired and reconnected.</p> <p>This option is suitable when one of the WAN connections fails and the traffic going through this WAN to the destination IP should go through the other WAN to reach the destination. In this way, when any of the WAN connections is broken, other WANs can serve as a backup; traffic can be shifted to a WAN that is still connected.</p>
Detecting Feedback Servers:	
Default Gateway:	<p>The local default communication gateway location, such as the IP address of an ADSL router, will be input automatically by the device. Therefore, users just need to check the option if this function is needed. Attention! Some gateways of an ADSL network will not affect packet detection. If users have an optical fiber box, or the IP issued by ISP is a public IP and the gateway is located at the port of the net café rather than at the IP provider's port, do not activate this option.</p>
ISP Host:	<p>This is the detected location for the ISP port, such as the DNS IP address of ISP. When configuring an IP address for this function, make sure this IP is capable of receiving feedback stably and speedily. (Please input the DNS IP of the ISP port)</p>
Remote Host:	<p>This is the detected location for the remote Network Segment. This Remote Host IP should better be capable of receiving feedback stably and speedily. (Please input the DNS IP of the ISP port).</p>
DNS Lookup Host:	<p>This is the detect location for DNS. (Only a web address such as www.hinet.net is acceptable here. Do not input an IP address.)</p>

	In addition, do not input the same web address in this box for two different WANs.
--	--

Note !

In the load balance mode for Assigned Routing, the first WAN port (WAN1) will be saved for the traffic of the IP addresses or the application service ports that are not assigned to other WANs (WAN2, WAN3, and WAN4). Therefore, in this mode, we recommend assigning one of the connections to the first WAN. When other WANs (WAN2, WAN3, or WAN4) are broken and connection error remove (Remove the Connection) has been selected for the connection detection system, traffic will be shifted to the first WAN (WAN1). In addition, if the first WAN (WAN1) is broken, the traffic will be shifted to other WANs in turn. For example, the traffic will be shifted to WAN2 first; if WAN2 is broken too, the traffic will be shifted to WAN3, and so on.

6.2.3 Protocol Binding

Bandwidth Configuration

When Auto Load Balance mode is selected, the device will select sessions or IP and the WAN bandwidth will automatically allocate connections to achieve load balancing for external connections. The network bandwidth is set by what users input for it. For example, if the upload bandwidth of both WANs is 512Kbit/sec, the automatic load ratio will be 1:1; if one of the upload bandwidths is 1024Kbit/sec, while the other is 512Kbit/sec, the automatic load ratio will be 2:1. Therefore, to ensure that the device can balance the actual network load, please input real upload and download bandwidths. The section refers to QoS configuration. Therefore, it should be set in QoS page. Please refer to 8.1 QoS bandwidth configuration.

▶ The Maximum Bandwidth provided by ISP

Interface	Upstream Bandwidth (Kbit/sec)	Downstream Bandwidth (Kbit/sec)
WAN 1	<input type="text" value="10000"/>	<input type="text" value="10000"/>
WAN 2	<input type="text" value="10000"/>	<input type="text" value="10000"/>
WAN 3	<input type="text" value="10000"/>	<input type="text" value="10000"/>
WAN 4	<input type="text" value="10000"/>	<input type="text" value="10000"/>

Protocol Binding

Users can define specific IP addresses or specific application service ports to go through a user-assigned WAN for external connections. For any other unassigned IP addresses and services, WAN load balancing will still be carried out.

Note !

In the load balance mode of Assigned Routing, the first WAN (WAN1) cannot be assigned. It is to be saved for the IP addresses and the application Service Ports that are not assigned to other WANs (WAN2, WAN3, and WAN4) for external connections. In other words, the first WAN (WAN1) cannot be configured with the Protocol Binding rule. This is to avoid a condition where all WANs are assigned to specific Intranet IP or Service Ports and destination IP, no more WAN ports will be available for other IP addresses and Service Ports.

Protocol Binding

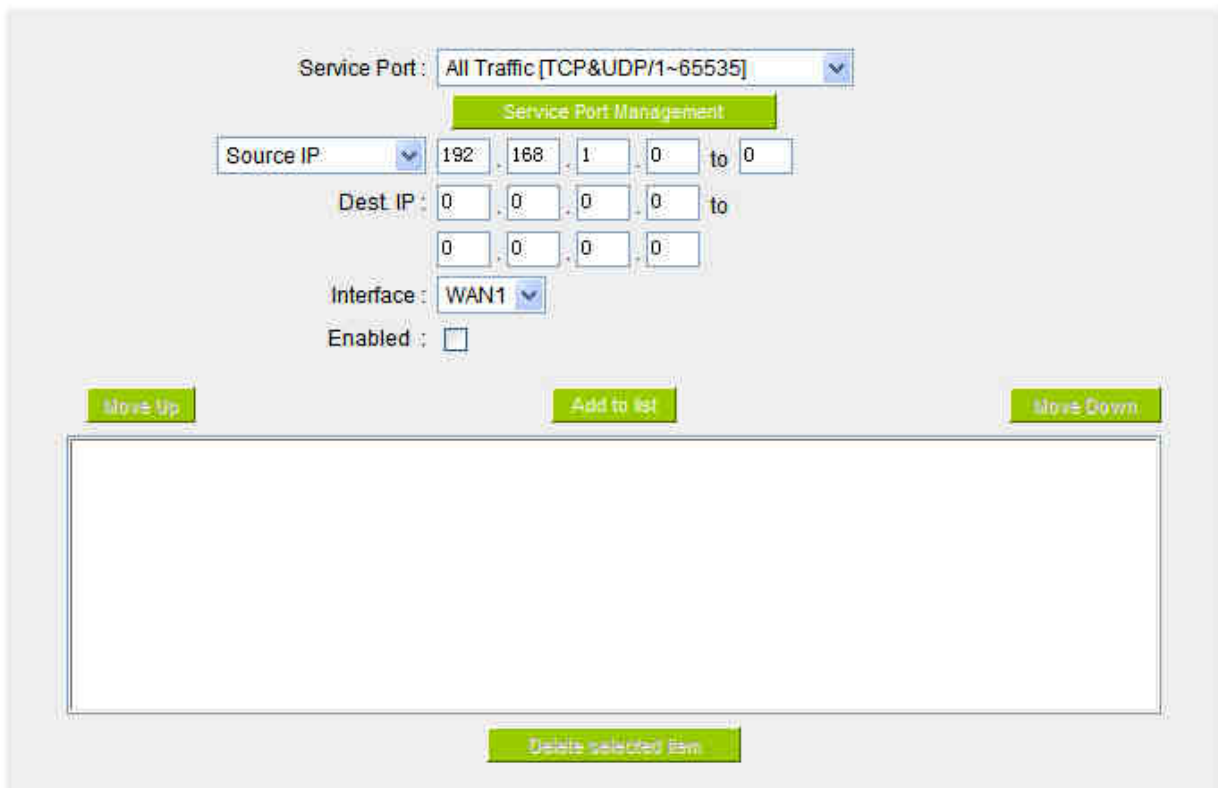

Service Port : All Traffic [TCP&UDP/1~65535]

Service Port Management

Source IP : 192 . 168 . 1 . 0 : to 0

Dest IP : 0 . 0 . 0 . 0 : to 0 . 0 . 0 . 0

Interface : WAN1

Enabled :

Move Up Add to list Move Down

Delete selected item

Show Table Apply Cancel

Service:	<p>This is to select the Binding Service Port to be activated. The default (such as ALL-TCP&UDP 0~65535, WWW 80~80, FTP 21 to 21, etc.) can be selected from the pull-down option list. The default Service is All 0~65535.</p> <p>Option List for Service Management: Click the button to enter the Service Port configuration page to add or remove default Service Ports on the option list.</p>
Source IP:	<p>Users can assign packets of specific Intranet virtual IP to go through a specific WAN port for external connection. In the boxes here, input the Intranet virtual IP address range; for example, if 192.168.1.100~150 is input, the binding range will be 100~150. If only specific Service Ports need to be designated, while specific IP designation is not necessary, input "0" in the IP boxes.</p>
Destination IP:	<p>In the boxes, input an external static IP address. For example, if connections to destination IP address 210.11.1.1 are to be restricted to WAN1, the external static IP address 210.1.1.1 ~ 210.1.1.1 should be input. If a range of destinations is to be assigned, input the range such as 210.11.1.1 ~ 210.11.255.254. This means the Class B Network Segment of 210.11.x.x will be restricted to a specific WAN. If only specific Service Ports need to be designated, while a specific IP destination assignment is not required, input "0" into the IP boxes.</p>
Interface:	Select the WAN for which users want to set up the binding rule.
Enable:	To activate the rule.
Add To List:	To add this rule to the list.
Delete selected application:	To remove the rules selected from the Service List.
Moving Up & Down:	The priority for rule execution depends on the rule order in the list. A rule located at the top will be executed prior to those located below it. Users can arrange the order according to their priorities.

Note !

The rules configured in Protocol Binding will be executed by the device according to their priorities too. The higher up on the list, the higher the priority of execution.

Show Table :

Click the "Show Table" button. A dialogue box as shown in the following figure will be displayed. Users can choose to sort the list by priorities or by interface. Click "Refresh" and the page will be refreshed; click "Close" and the dialogue box will be closed.

<input checked="" type="radio"/> Priority <input type="radio"/> Interface <input type="button" value="Refresh"/> <input type="button" value="Close"/>						
Priority	Interface	Service Port	Source IP	Dest. IP	Enabled	Edit

Add or Remove Service Port

If the Service Port users want to activate is not in the list, users can add or remove service ports from "**Service Port Management**" to arrange the list, as described in the following :

Service Name :

Protocol :

Port Range : to

All Traffic [TCP&UDP/1~65535]

DNS [UDP/53~53]

FTP [TCP/21~21]

HTTP [TCP/80~80]

HTTP Secondary [TCP/8080~8080]

HTTPS [TCP/443~443]

HTTPS Secondary [TCP/8443~8443]

TFTP [UDP/69~69]

IMAP [TCP/143~143]

NNTP [TCP/119~119]

POP3 [TCP/110~110]

SNMP [UDP/161~161]

SMTP [TCP/25~25]

TELNET [TCP/23~23]

TELNET Secondary [TCP/8023~8023]

TELNETSSL [TCP/992~992]

DHCP [UDP/67~67]

L2TP [UDP/1701~1701]

Service Name:	In this box, input the name of the Service Port which users want to activate, such as BT, etc.
Protocol:	This option list is for selecting a packet format, such as TCP or UDP for the Service Ports users want to activate.
Port range:	In the boxes, input the range of Service Ports users want to add.
Add To List:	Click the button to add the configuration into the Services List. Users can add up to 100 services into the list.
Delete selected service:	To remove the selected activated Services.
Apply:	Click the "Apply" button to save the modification.
Cancel:	Click the "Cancel" button to cancel the modification. This only works before "Apply" is clicked.
Close:	To quit this configuration window.

Auto Load Balancing mode when enabled :

The collocation of the Auto Load Balance Mode and the Auto Load Mode will enable more flexible use of bandwidth. Users can assign specific Intranet IP addresses to specific destination application service ports or assign specific destination IP addresses to a WAN users choose for external connections.

Example 1 : How do I set up Auto Load Balance Mode to assign the Intranet IP 192.168.1.100 to WAN2 for the Internet?

As in the figure below, select "All Traffic" from the pull-down option list "Service", and then in the boxes of "Source IP" input the source IP address "192.168.1.100" to "100". Retain the original numbers "0.0.0.0" in the boxes of "Destination IP" (which means to include all Internet IP addresses). Select WAN2 from the pull-down option list "Interface", and then click "Enable". Finally, click "Add New" and the rule will be added to the mode.

Protocol Binding

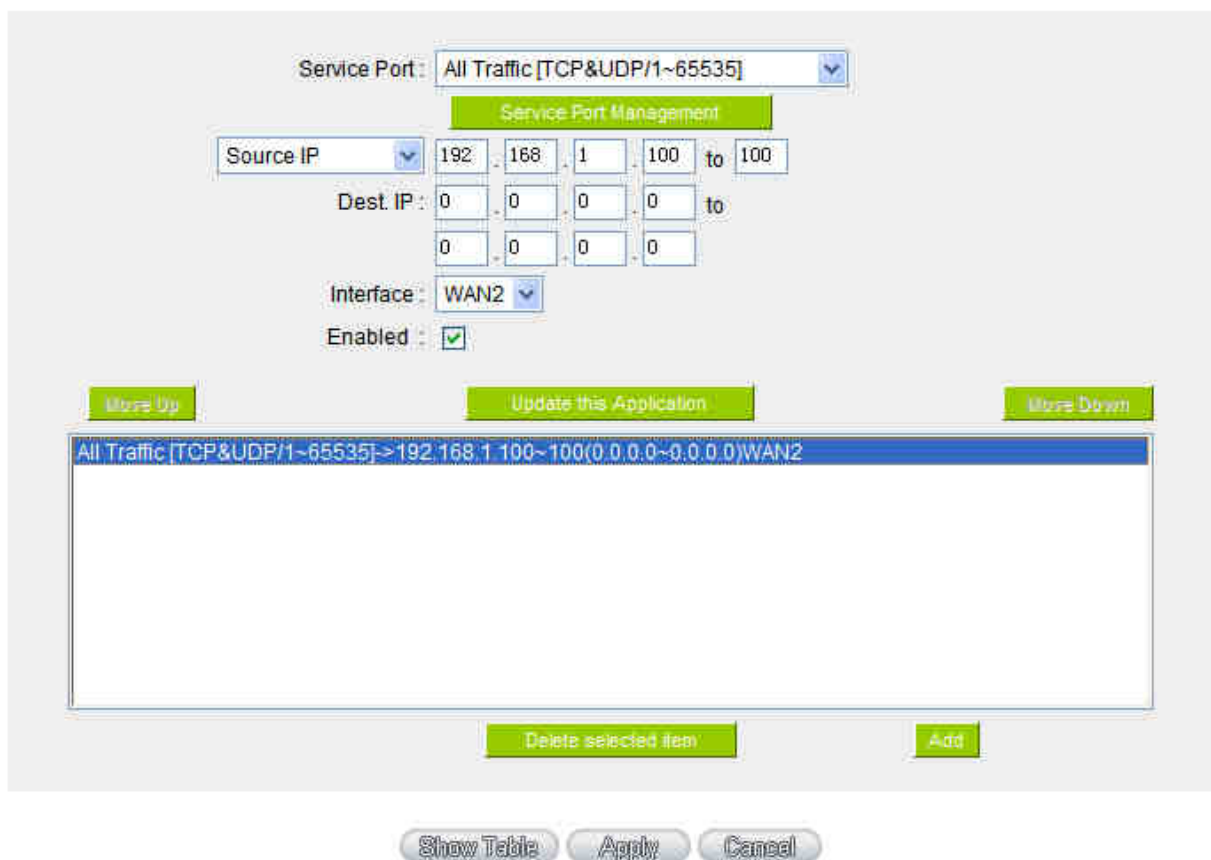

Service Port: All Traffic [TCP&UDP/1~65535]

Source IP: 192 . 168 . 1 . 100 to 100

Dest. IP: 0 . 0 . 0 . 0 to 0 . 0 . 0 . 0

Interface: WAN2

Enabled:

More Up Update this Application More Down

All Traffic [TCP&UDP/1~65535]->192.168.1.100~100(0.0.0.0~0.0.0.0)WAN2

Delete selected item Add

Show Table Apply Cancel

Example 2 : How do I set up Auto Load Balance Mode to keep Intranet IP 192.168.1.150 ~ 200 from going through WAN2 when the destination port is Port 80?

As in the figure below, select "HTTP [TCP/80~80]" from the pull-down option list "Service", and then in the boxes for "Source IP" input "192.168.1.150" to "200". Retain the original numbers "0.0.0.0" in the boxes of "Destination IP" (which means to include all Internet IP addresses). Select WAN2 from the pull-down option list "Interface", and then click "Enable". Finally, click "Add New" and the rule will be added to the mode.

Protocol Binding

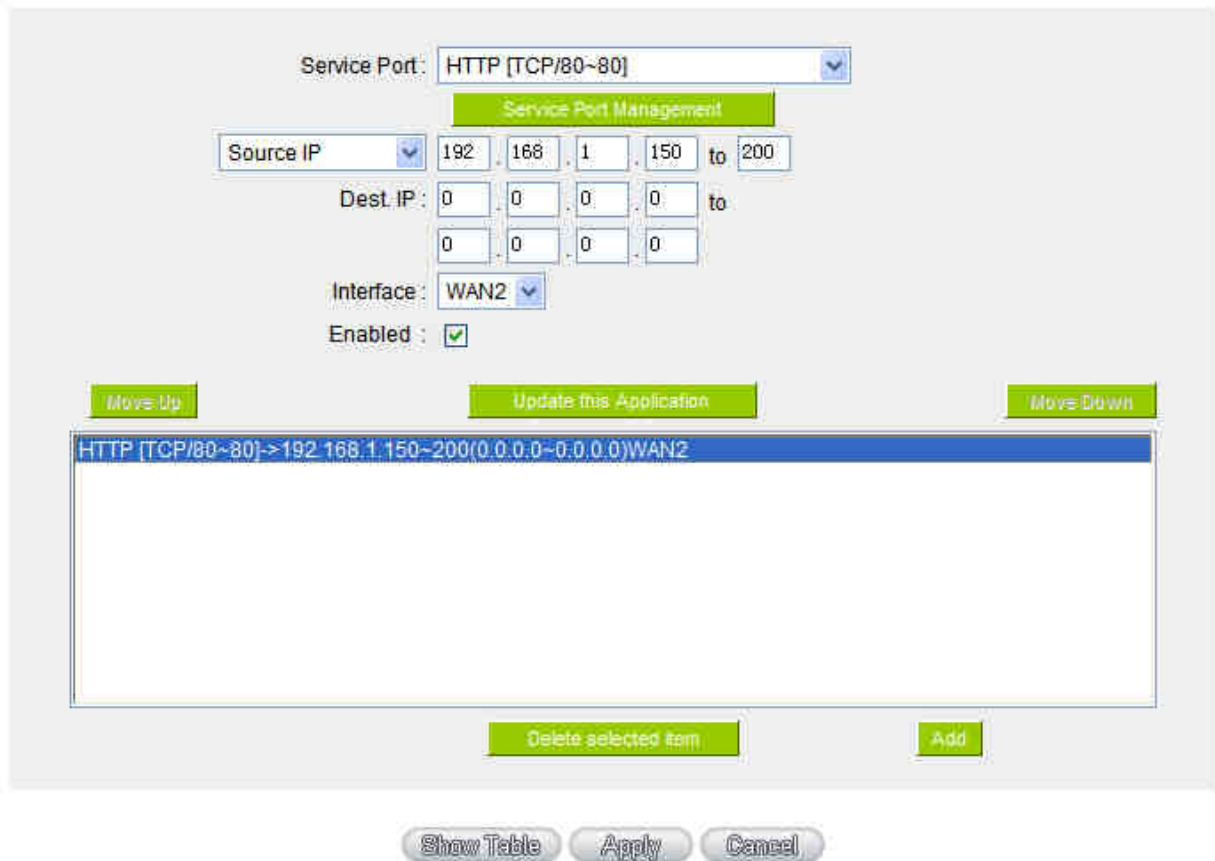

Service Port: HTTP [TCP/80~80]

Source IP: 192 . 168 . 1 . 150 to 200

Dest. IP: 0 . 0 . 0 . 0 to 0 . 0 . 0 . 0

Interface: WAN2

Enabled:

Move Up Update this Application Move Down

HTTP [TCP/80~80]->192.168.1.150~200(0.0.0.0~0.0.0.0)WAN2
--

Delete selected item Add

Show Table Apply Cancel

Example 3 : How do I set up Auto Load Balance Mode to keep all Intranet IP addresses from going through WAN2 when the destination port is Port 80 and keep all other services from going through WAN1?

As in the figure below, there are two rules to be configured. The first rule: select "HTTP [TCP/80~80]" from the pull-down option list "Service", and then in the boxes of Source IP input "192.168.1.0" to "0" (which means to include all Intranet IP addresses). Retain the original numbers "0.0.0.0" in the boxes of "Destination IP" (Which means to include all Internet IP addresses). Select WAN2 from the pull-down option list "Interface", and then click "Enable". Finally, click "Add New" and the rule will be added to the mode. The device will transmit packets to Port 80 through WAN2. However, with only the above rule, packets that do not go to Port 80 may be transmitted through WAN2; therefore, a second rule is necessary. The second rule: Select "All Ports [TCP&UDP/1~65535]" from the pull-down option list "Service", and then input "192.168.1.2 ~ 254" in the boxes of "Source IP". Retain the original numbers "0.0.0.0" in the boxes of "Destination IP" (which means to include all

Internet IP addresses). Select WAN1 from the pull-down option list "Interface", and then click "Enable". Finally, click "Add New" and the rule will be added to the mode. The device will transmit packets that are not going to Port 80 to the Internet through WAN1.

Protocol Binding

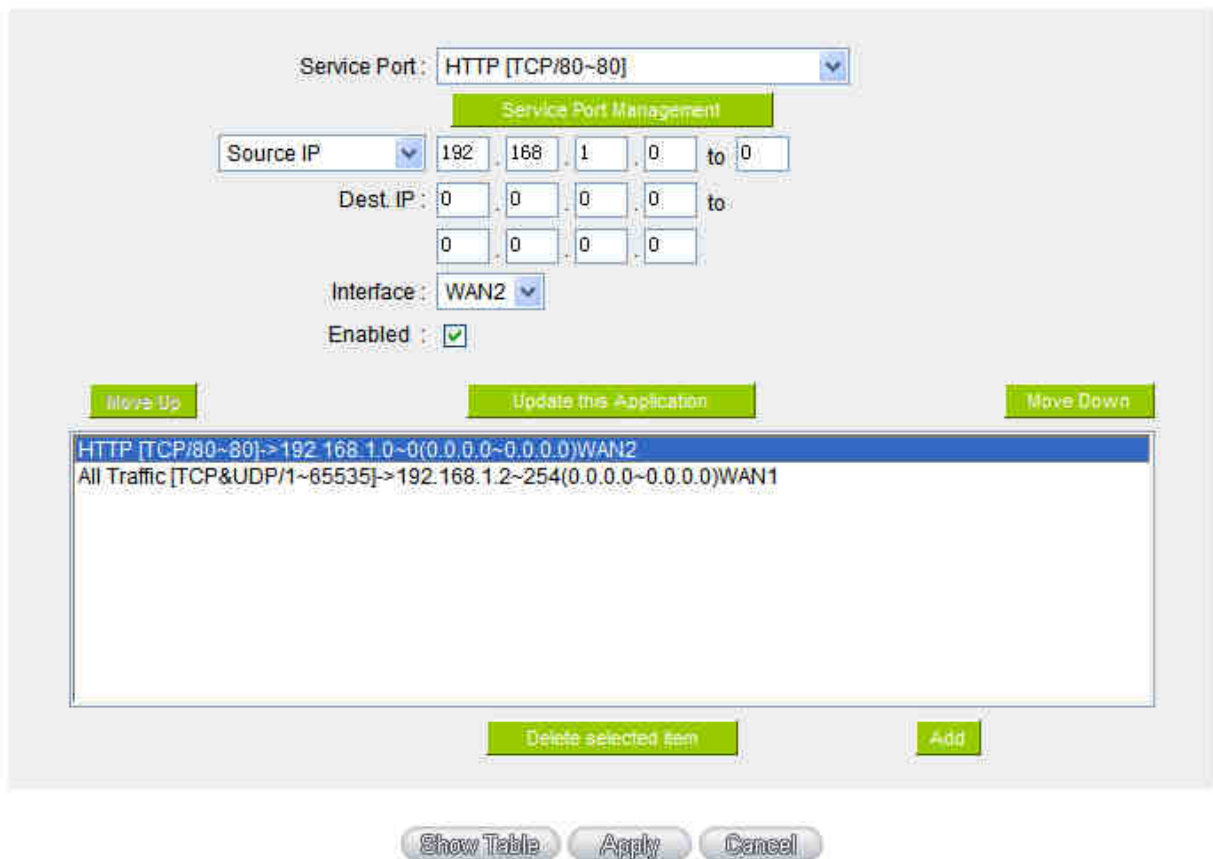

Service Port: HTTP [TCP/80~80]

Source IP: 192 . 168 . 1 . 0 to 0

Dest. IP: 0 . 0 . 0 . 0 to 0 . 0 . 0 . 0

Interface: WAN2

Enabled:

Move Up Update this Application Move Down

HTTP [TCP/80~80]->192.168.1.0~0(0.0.0.0~0.0.0.0)WAN2
All Traffic [TCP&UDP/1~65535]->192.168.1.2~254(0.0.0.0~0.0.0.0)WAN1

Delete selected item Add

Show Table Apply Cancel

Configuring "Assigned Routing Mode" for load Balance :

IP Group: This function allows users to assign packets from specific Intranet IP addresses or to specific destination Service Ports and to specific destination IP addresses through an assigned WAN to the Internet. After being assigned, the specific WAN will only support those assigned Intranet IP addresses, destination Service Ports, or destination IP addresses. Those which are not configured will go through other WANs for external connection. Only when this mode is collocated with "Assigned Routing" can it bring the function into full play.

Example 1 : How do I set up the Assigned Routing Mode to keep all Intranet IP addresses from going through WAN2 when the destination is Port 80, and keep all other services from going

through WAN1?

As in the figure below, select "HTTP[TCP/80~80]" from the pull-down option list "Service", and then in the boxes of "Source IP" input "192.168.1.0 ~ 0" (which means to include all Intranet IP addresses). Retain the original numbers "0.0.0.0" in the boxes of "Destination IP" (Which means to include all Internet IP addresses). Select WAN2 from the pull-down option list "Interface", and then click "Enable". Finally, click "Add New" and the rule will be added to the mode. After the rule is set up, only packets that go to Port 80 will be transmitted through WAN2, while other traffics will be transmitted through WAN1.

Protocol Binding

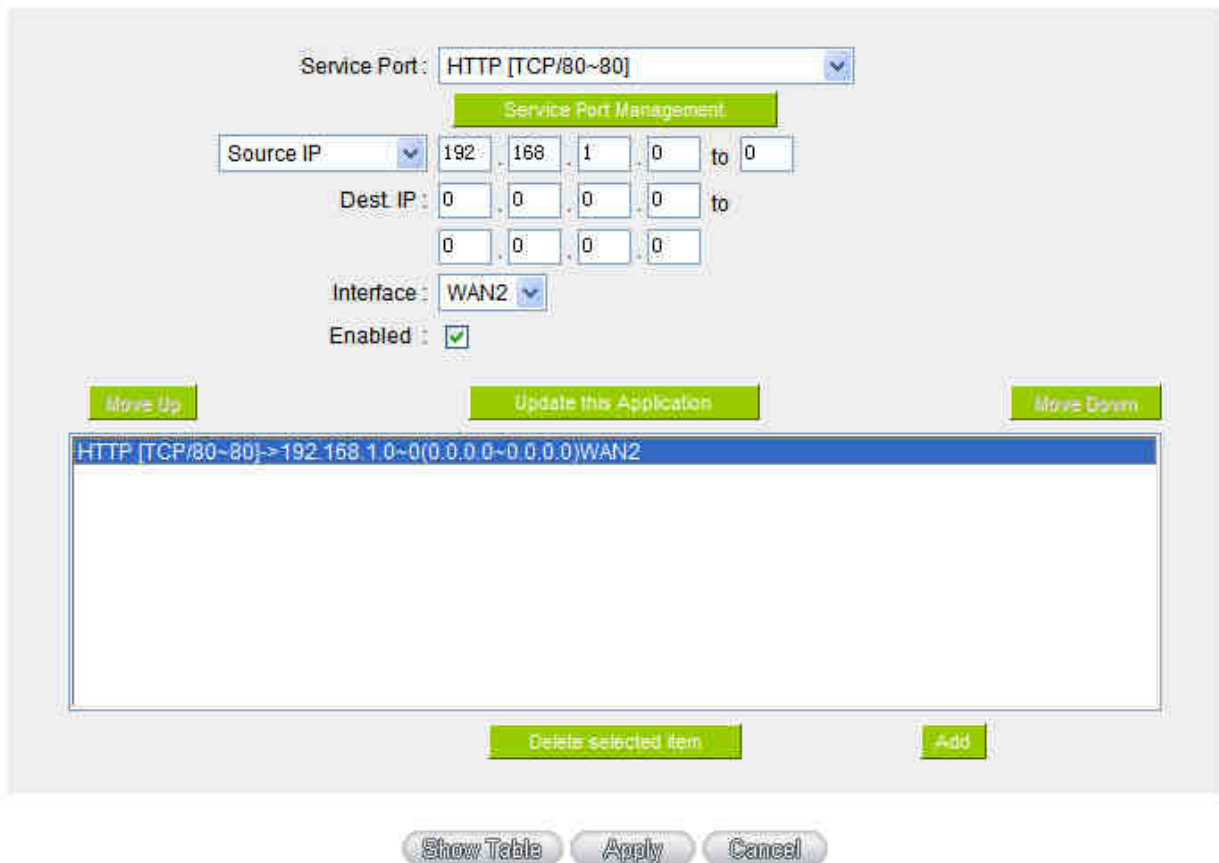

Service Port: HTTP [TCP/80~80]

Source IP: 192 . 168 . 1 . 0 to 0

Dest IP: 0 . 0 . 0 . 0 to 0 . 0 . 0 . 0

Interface: WAN2

Enabled:

Move Up Update this Application Move Down

HTTP [TCP/80~80]->192.168.1.0~0(0.0.0.0~0.0.0.0)WAN2
--

Delete selected item Add

Show Table Apply Cancel

Example 2 : How do I configure Protocol Binding to keep traffic from all Intranet IP addresses from going through WAN2 when the destinations are IP 211.1.1.1 ~ 211.254.254.254 as well as the whole Class A group of 60.1.1.1 ~ 60.254.254.254, while traffic to other destinations goes through WAN1?

As in the following figure, there are two rules to be configured. The first rule: Select "All

Port [TCP&UDP/1~65535]" from the pull-down option list "Service", and then in the boxes of "Source IP" input "192.168.1.0 ~ 0" (which means to include all Intranet IP addresses). In the boxes for "Destination IP" input "211.1.1.1 ~ 211.254.254.254". Select WAN2 from the pull-down option list "Interface", and then click "Enable". Finally, click "Add New" and the rule will be added to the mode. The second rule: Select "All Port [TCP&UDP/1~65535]" from the pull-down option list "Service", and then in the boxes of "Source IP" input "192.168.1.0 ~ 0" (which means to include all Intranet IP addresses). In the boxes of "Destination IP" input "211.1.1.1 ~ 60,254,254,254". Select WAN2 from the pull-down option list "Interface", and then click "Enable". Finally, click "Add New", and the rule will be added to the mode. After the rule has been set up, all traffic that is not going to the assigned destinations will only be transmitted through WAN1.

Protocol Binding

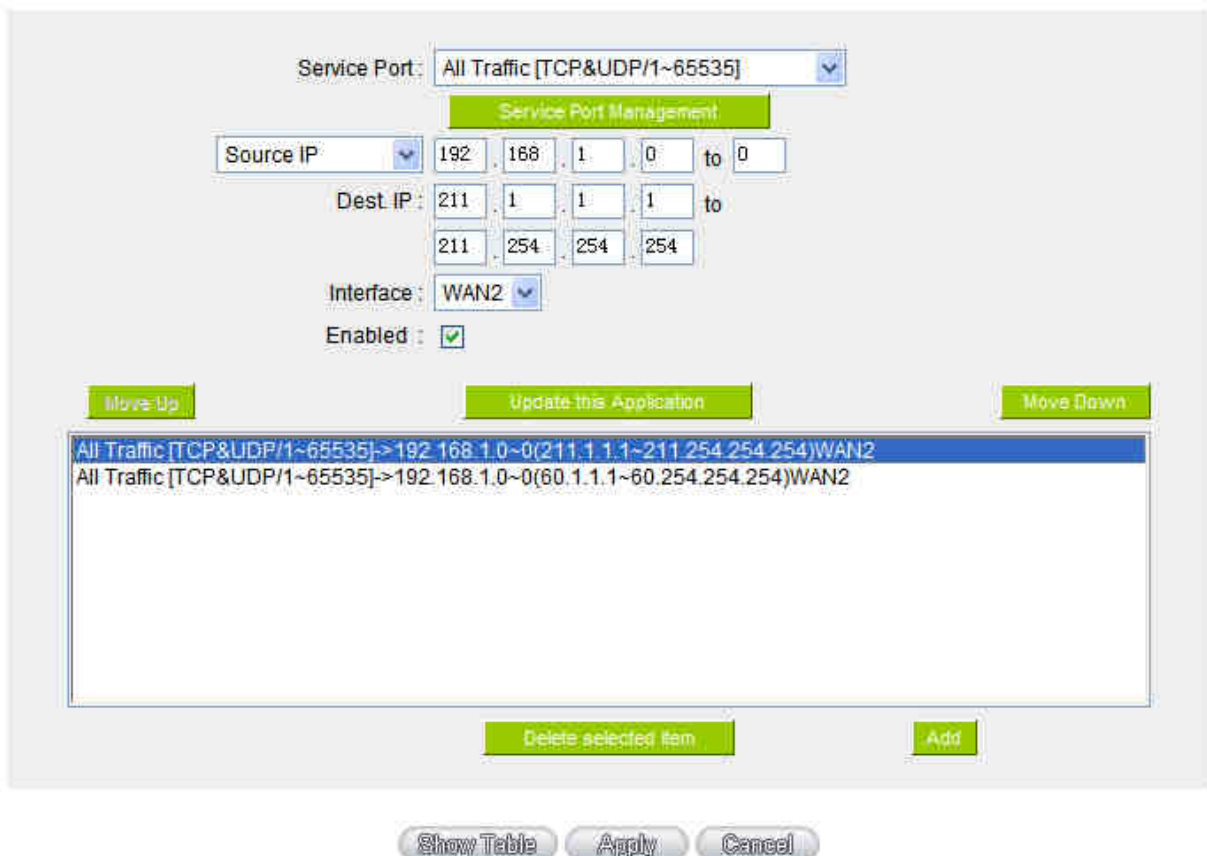

Service Port: All Traffic [TCP&UDP/1~65535]

Service Port Management

Source IP: 192 . 168 . 1 . 0 to 0

Dest IP: 211 . 1 . 1 . 1 to 211 . 254 . 254 . 254

Interface: WAN2

Enabled:

Move Up Update this Application Move Down

All Traffic [TCP&UDP/1~65535]->192.168.1.0~0(211.1.1.1~211.254.254.254)WAN2
All Traffic [TCP&UDP/1~65535]->192.168.1.0~0(60.1.1.1~60.254.254.254)WAN2

Delete selected item Add

Show Table Apply Cancel

VII. Port Management

This chapter introduces how to configure ports and understand how to configure intranet IP addresses.

7.1 Setup

Through the device, users can easily manage the setup for WAN ports, LAN ports and the DMZ port by choosing the number of ports, speed, priority, duplex and enable/disable the auto-negotiation feature for connection setting of each port.

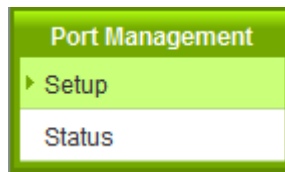

Setup

Please choose how many WAN ports you prefer to use : 4 (Default: 4)

Enable Port 1 as Mirror Port

Port ID	Interface	Disabled	Priority	Speed Status	Duplex Status	Auto Neg.	VLAN
1	LAN	<input type="checkbox"/>	Normal	100M	Full	<input checked="" type="checkbox"/>	VLAN1
2	LAN	<input type="checkbox"/>	Normal	100M	Full	<input checked="" type="checkbox"/>	VLAN1
3	LAN	<input type="checkbox"/>	Normal	100M	Full	<input checked="" type="checkbox"/>	VLAN1
4	LAN	<input type="checkbox"/>	Normal	100M	Full	<input checked="" type="checkbox"/>	VLAN1
5	LAN	<input type="checkbox"/>	Normal	100M	Full	<input checked="" type="checkbox"/>	VLAN1
6	LAN	<input type="checkbox"/>	Normal	100M	Full	<input checked="" type="checkbox"/>	VLAN1
7	LAN	<input type="checkbox"/>	Normal	100M	Full	<input checked="" type="checkbox"/>	VLAN1
8	LAN	<input type="checkbox"/>	Normal	100M	Full	<input checked="" type="checkbox"/>	VLAN1
9	LAN	<input type="checkbox"/>	Normal	100M	Full	<input checked="" type="checkbox"/>	VLAN1
10	LAN	<input type="checkbox"/>	Normal	100M	Full	<input checked="" type="checkbox"/>	VLAN1
11	LAN	<input type="checkbox"/>	Normal	100M	Full	<input checked="" type="checkbox"/>	VLAN1
12	WAN4	<input type="checkbox"/>	Normal	100M	Full	<input checked="" type="checkbox"/>	
13	WAN3	<input type="checkbox"/>	Normal	100M	Full	<input checked="" type="checkbox"/>	
14	WAN2	<input type="checkbox"/>	Normal	100M	Full	<input checked="" type="checkbox"/>	
15	WAN1	<input type="checkbox"/>	Normal	100M	Full	<input checked="" type="checkbox"/>	
16	DMZ	<input type="checkbox"/>	Normal	100M	Full	<input checked="" type="checkbox"/>	

Mirror Port : Users can configure LAN 1 as mirror port by choosing "Enable Port 1 as Mirror Port". All the traffic from LAN to WAN will be copied to mirror port. Administrator can control or filter the traffic through mirror port. Once this function is enabled, LAN 1 will be shown as Mirror Port in Physical Port Status, Home page.

Physical Port Status

Port ID	1	2	3	4	5	6	7	8
Interface	Mirror Port	LAN						
Status	Connect	Enabled	Enabled	Enabled	Enabled	Enabled	Enabled	Enabled
Port ID	9	10	11	12	13	14	15	DMZ
Interface	LAN			WAN 4	WAN 3	WAN 2	WAN 1	DMZ
Status	Enabled	Enabled	Enabled	Enabled	Enabled	Connect	Enabled	Enabled

Disabled :	This feature allows users turn on/off the Ethernet port. If selected, the Ethernet port will be shut down immediately and no connection can be made. The default value is "on".
Priority :	This feature allows users to set the high/low priority of the packet delivery for the Ethernet port. If it is set as High, the port has the first priority to deliver the packet. The default value is "Normal".
Speed :	This feature allows users to select the network hardware connection speed for the Ethernet port. The options are 10Mbps and 100Mbps.
Duplex Status :	This feature allows users to select the network hardware connection speed working mode for the Ethernet. The options are full duplex and half duplex.
Auto Neg. :	The Auto-Negotiation mode can enable each port to automatically adjust and gather the connection speed and duplex mode. Therefore, if Enabled Auto-Neg. selected, the ports setup will be done without any manual setting by administrators.
VLAN :	This feature allows administrators to set the LAN port to be one or more disconnected network sessions. All of them will be able to log on to the Internet through the device. Members in the same network session (within the same VLAN) can see and communicate with each other. Members in different VLAN will not know the existence of other members.
VLAN All :	Set VLAN All port to be the public area of VLAN so that it can be connected to other VLAN networks. A server should be constructed for the intranet so that all VLAN group can visit this server. Set one of the network ports as VLAN All. Connect the server to VLAN All so that computers of different VLAN groups can be connected to this server. Moreover, the port where the administrator locates must be set as VLAN All so that it can be connected to the entire network to facilitate network management.

7.2 Port Status

Port Management

Setup

▶ Status

Port ID : ▼

Summary

Type	10Base-T / 100Base-TX
Interface	LAN
Link Status	Up
Physical Port Status	Port Enabled
Priority	Normal
Speed Status	100 Mbps
Duplex Status	Full
Auto Neg.	Enabled
VLAN	VLAN1

Statistics

Receive Packets Count	0
Receive Packets Byte Count	360788963
Transmit Packets Count	0
Transmit Packets Byte Count	497225689
Error Packets Count	0

Refresh

Summary :

There are Network Connection Type, Interface, Link Status (Up/Down), Port Activity (Port Enabled), Priority Setting (High or Normal), Speed Status (10Mbps or 100Mbps), Duplex Status (half duplex or full duplex), Auto Neg. (Enabled/Disabled), and VLAN.



Enterprise Multi-WAN VPN QoS Router

Statistics :

The packet data of this specific port will be displayed. Data include receive/ transmit packet count, receive/ transmit packet Byte count and error packet count. Users may press the refresh button to update all real-time messages.

7.3 IP/ DHCP

With an embedded DHCP server, it supports automatic IP assignment for LAN computers. (This function is similar to the DHCP service in NT servers.) It benefits users by freeing them from the inconvenience of recording and configuring IP addresses for each PC respectively. When a computer is turned on, it will acquire an IP address from the device automatically. This function is to make management easier.

IP/DHCP	
▶	Setup
	Status
	IP & MAC Binding
	IP Grouping

Enabled DHCP Server

▶ DHCP Client IP Range

Client Lease Time minutes

Range Start:	192 . 168 . <input type="text" value="1"/> . <input type="text" value="100"/>
Range End:	192 . 168 . <input type="text" value="1"/> . <input type="text" value="149"/>

▶ DNS

DNS Server(Required) 1:	<input type="text" value="0"/> . <input type="text" value="0"/> . <input type="text" value="0"/> . <input type="text" value="0"/>
DNS Server(Optional) 2:	<input type="text" value="0"/> . <input type="text" value="0"/> . <input type="text" value="0"/> . <input type="text" value="0"/>

▶ WINS

WINS Server:	<input type="text" value="0"/> . <input type="text" value="0"/> . <input type="text" value="0"/> . <input type="text" value="0"/>
--------------	---

Dynamic IP :

Client lease Time :	Check the option to activate the DHCP server automatic IP lease function. If the function is activated, all PCs will be able to acquire IP automatically. Otherwise, users should configure static virtual IP for each PC individually.
Range Start :	This is to set up a lease time for the IP address which is acquired by a PC. The default is 1440 minutes (a day). Users can change it according to their needs. The time unit is minute.
Range End :	This is an initial IP automatically leased by DHCP. It means DHCP will start the lease from this IP. The default initial IP is 192.168.1.100.

DNS (Domain Name Service) :

This is for checking the DNS from which an IP address has been leased to a PC port. Input the IP address of this server directly.

DNS (Required) 1 :	Input the IP address of the DNS server.
DNS (Optional) 2 :	Input the IP address of the DNS server.

WINS :

If there is a WIN server in the network, users can input the IP address of that server directly.

WINS Server :	Input the IP address of WINS.
Apply :	Click " Apply " to save the network configuration modification.
Cancel :	Click " Cancel " to leave without making any changes.

7.4 DHCP Status

This is an indication list of the current status and setup record of the DHCP server. The indications are for the administrator's reference when a network modification is needed.

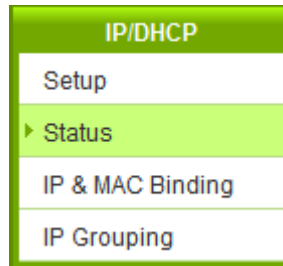

▶ Status

DHCP Server :	192.168.1.1
Dynamic IP Used :	1
Static IP Used :	0
IP Available :	49
Total IP :	50

▶ DHCP Client Table

Host Name	IP Address	MAC Address	Client Lease Time	Delete
PC95009	192.168.1.100	00:16:e6:50:13:32	Wed Dec 24 08:16:04 2008	

Refresh

DHCP Server :	This is the current DHCP IP.
Dynamic IP Used :	The amount of dynamic IP leased by DHCP.
Static IP Used :	The amount of static IP assigned by DHCP.
IP Available :	The amount of IP still available in the DHCP server.
Total IP :	The total IP which the DHCP server is configured to lease.
Host Name :	The name of the current computer.

IP Address :	The IP address acquired by the current computer.
MAC Address :	The actual MAC network location of the current computer.
Client Lease Time :	The lease time of the IP released by DHCP.
Delete :	Remove a record of an IP lease.

7.5 IP & MAC Binding

Administrators can apply IP & MAC Binding function to make sure that users can not add extra PCs for Internet access or change private IP addresses.

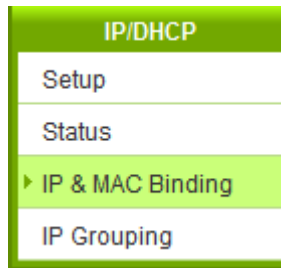

IP & MAC Binding

[Show new IP user](#)

Static IP : - - -

MAC Address : - - - - -

Name :

Enabled :

[Add to list](#)

[Delete selected item](#)

- Block MAC address on the list with wrong IP address
- Block MAC address not on the list

[Show Table](#) [Apply](#) [Cancel](#)

There are two methods for setting up this function :

Block MAC address not on the list

This method only allows MAC addresses on the list to receive IP addresses from DHCP and have Internet access. When this method is applied, please fill out Static IP with 0.0.0.0, as the figure below :

IP & MAC Binding

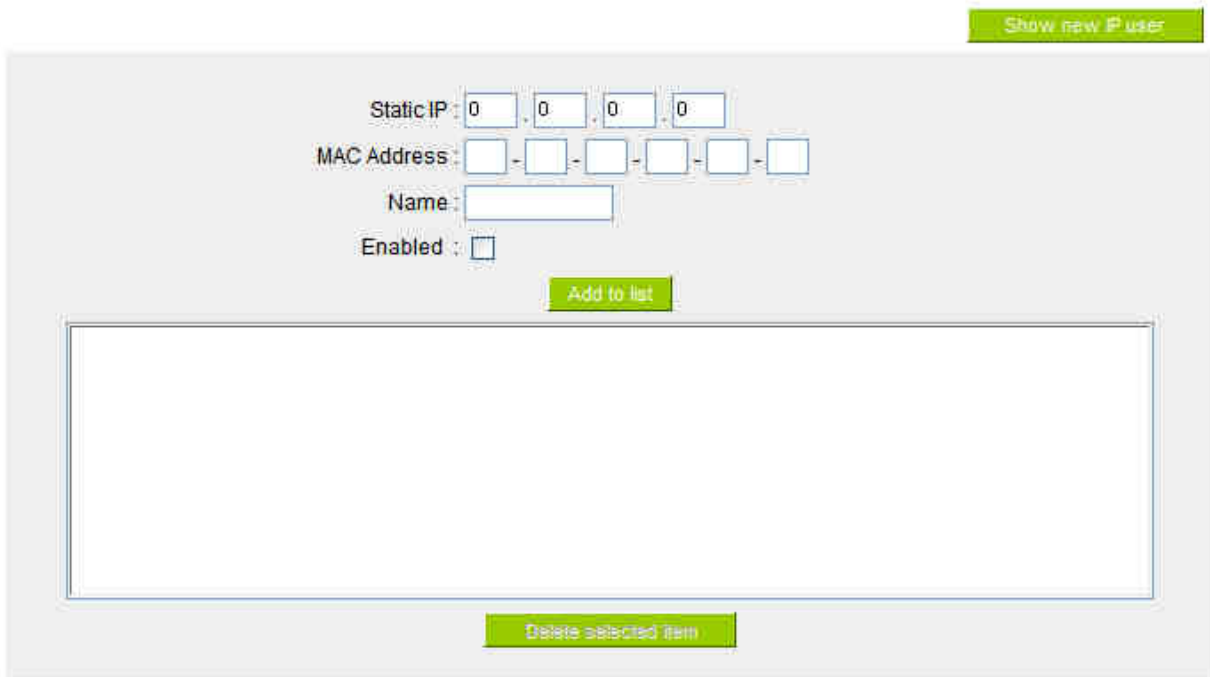

- Block MAC address on the list with wrong IP address
- Block MAC address not on the list

Show Table Apply Cancel

IP & MAC Binding

IP & MAC Binding

Show new IP user

Static IP : - - -

MAC Address : - - - - -

Name :

Enabled :

Add to list

Delete selected item

- Block MAC address on the list with wrong IP address
- Block MAC address not on the list

Show Table Apply Cancel

<p>Static IP :</p>	<p>There are two ways to input static IP:</p> <ol style="list-style-type: none"> 1. If users want to set up a MAC address to acquire IP from DHCP, but the IP need not be a specific assigned IP, input 0.0.0.0 in the boxes. The boxes cannot be left empty. 2. If users want DHCP to assign a static IP for a PC every single time, users should input the IP address users want to assign to this computer in the boxes. The server or PC which is to be bound will then acquire a static virtual IP whenever it restarts.
<p>MAC Address :</p>	<p>Input the static real MAC (the address on the network card) for the server or PC which is to be bound.</p>

Name :	For distinguishing clients, input the name or address of the client that is to be bound. The maximum acceptable characters are 12.
Enabled :	Activate this configuration.
Add to list :	Add the configuration or modification to the list.
Delete selected item :	Remove the selected binding from the list.
Add :	Add new binding.

Block MAC address on the list with wrong IP address : When this option is activated, MAC addresses which are not included in the list will not be able to connect with the Internet.

Show New IP user :

This function can reduce administrator's effort on checking MAC addresses one by one for the binding. Furthermore, it is easy to make mistakes to fill out MAC addresses on the list manually. By checking this list, administrator can see all MAC addresses which have traffic and are not bound yet. Also, if administrators find that one specific bound MAC address is shown on the list, it means that the user changes the private IP address.

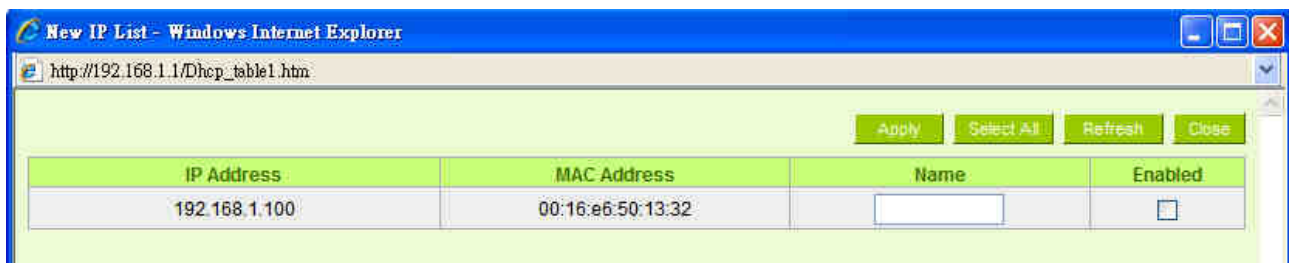

Name :	Input the name or address of the client that is to be bound. The maximum acceptable characters are 12.
Enabled :	Choose the item to be bound.
Apply :	Activate the configuration.
Select All :	Choose all items on the list for binding.
Refresh :	Refresh the list.
Close :	Close the list.

7.6 IP Grouping

The function enables users to make the same configuration for a range of continuous IP addresses in the network. For example, if an IP range (192.168.1.100~192.168.1.110) has been assigned to a department of a company, we can bind all the IP addresses together and make an accessing rule configuration for them all at the same time, instead of configuring each IP respectively, which takes more time and is more prone to error.

IP Grouping

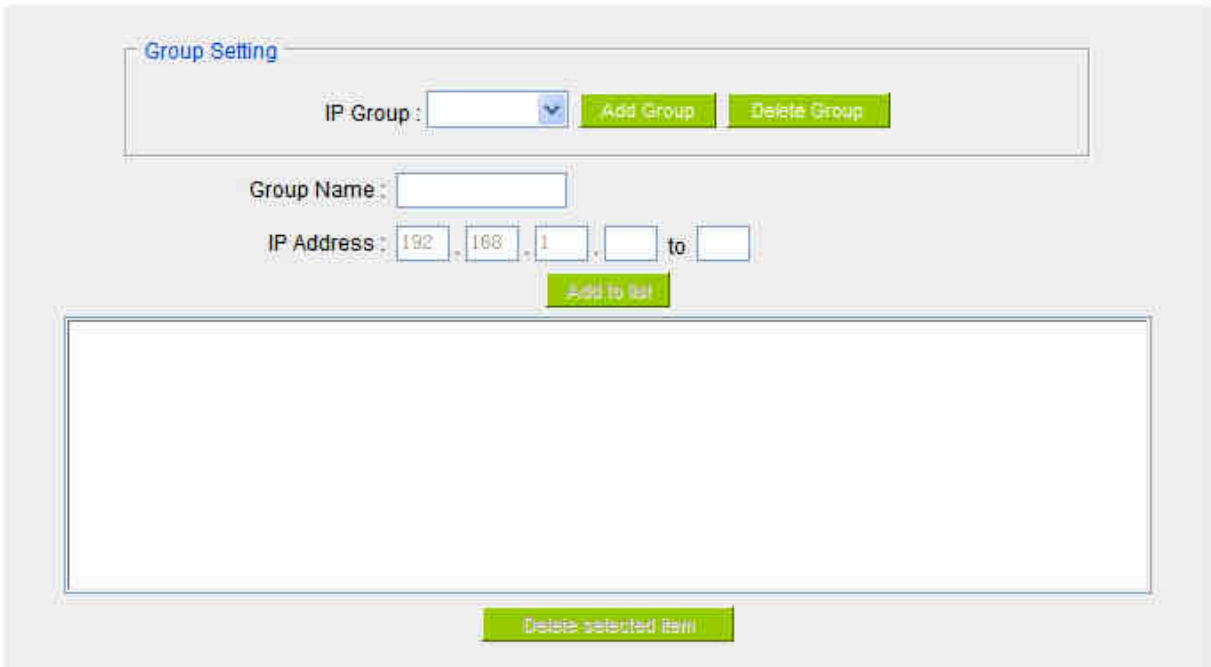

IP Group :	Select a group to which the modification is to be made.
Add Group :	Click Add Group to create a new IP group.
Delete Group :	Delete the chosen IP group.
Group Name :	Input or change the name for the group.
IP Address :	Input the assigned IP range.
Add to list :	Add the configuration or modification to the list.
Delete selected item :	Remove the selected binding from the list.
Apply :	Click "Apply" to save the network configuration modification
Cancel :	Click "Cancel" to leave without making any changes.

VIII. QoS (Quality of Service)

QoS is an abbreviation for Quality of Service. The main function is to restrict bandwidth usage for some services and IP addresses to save bandwidth or provide priority to specific applications or services, and also to enable other users to share bandwidth, as well as to ensure stable and reliable network transmission. To maximize the bandwidth efficiency, network administrators should take account of the practical requirements of a company, a community, a building, or a café, etc., and modify bandwidth management according to the network environment, application processes or services.



8.1 Bandwidth Management

▶ The Maximum Bandwidth provided by ISP

Interface	Upstream Bandwidth (Kbit/sec)	Downstream Bandwidth (Kbit/sec)
WAN 1	10000	10000
WAN 2	10000	10000
WAN 3	10000	10000
WAN 4	10000	10000

▶ Quality of Service

Type : Rate Control Priority

Interface : WAN 1 WAN 2 WAN 3 WAN 4

Service Port : All Traffic [TCP&UDP/1~65535]

Service Port Management

IP Address : 192 . 168 . 1 . 0 to 0

Direction : Upstream

Mini. Rate : Kbit/sec. Max. Rate : Kbit/sec.

Bandwidth Assign Type : Share total bandwidth with all IP addresses.
 Assign bandwidth for each IP address.

8.1.1 The Maximum Bandwidth provided by ISP

▶ The Maximum Bandwidth provided by ISP

Interface	Upstream Bandwidth (Kbit/sec)	Downstream Bandwidth (Kbit/sec)
WAN 1	10000	10000
WAN 2	10000	10000
WAN 3	10000	10000
WAN 4	10000	10000

In the boxes for WAN1 and WAN2 bandwidth, input the upstream and downstream bandwidth which users applied for from bandwidth supplier. The bandwidth QoS will make calculations according to the data users input. In other words, it will guarantee a minimum

rate of upstream and downstream for each IP and Service Port based on the total actual bandwidth of WAN1 and WAN2. For example, if the upstream bandwidths of both WAN1 and WAN2 are 512Kbit/Sec, the total upstream bandwidth will be: WAN1 + WAN2 = 1024Kbit/Sec. Therefore, if there are 50 IP addresses in the Intranet, the minimum guaranteed upstream bandwidth for each IP would be $1024\text{Kbit}/50=20\text{Kbit/Sec}$. Thus, 20Kbit/Sec can be input for "Mini. Rate" Downstream bandwidth can be calculated in the same way.

Attention !

The unit of calculation in this example is Kbit. Some software indicates the downstream/upstream speed with the unit KB. $1\text{KB} = 8\text{Kbit}$.

8.1.2 QoS

To satisfy the bandwidth requirements of certain users, the device enables users to set up QoS: Rate Control and Priority Control. Users can select only one of the above QoS choices.

Rate Control :

The network administrator can set up bandwidth or usage limitations for each IP or IP range according to the actual bandwidth. The network administrator can also set bandwidth control for certain Service Ports. A guarantee bandwidth control for external connections can also be configured if there is an internal server.

Quality of Service

Type : Rate Control Priority

Interface : WAN 1 WAN 2 WAN 3 WAN 4

Service Port : All Traffic [TCP&UDP/1~65535]

IP Address : 192 . 168 . 1 . 0 to 0

Direction : Upstream

Mini. Rate : Kbit/sec Max. Rate : Kbit/sec

Bandwidth Assign Type : Share total bandwidth with all IP addresses.
 Assign bandwidth for each IP address.

Enabled :

Interface :	Select on which WAN the QoS rule should be executed. It can be a single selection or multiple selections.
Service Port :	Select what bandwidth control is to be configured in the QoS rule. If the bandwidth for all services of each IP is to be controlled, select "All (TCP&UDP) 1~65535". If only FTP uploads or downloads need to be controlled, select "FTP Port 21~21". Refer to the Default Service Port Number List.

<p>IP Address :</p>	<p>This is to select which user is to be controlled. If only a single IP is to be restricted, input this IP address, such as "192.168.1.100 to 100". The rule will control only the IP 192.168.1.100. If an IP range is to be controlled, input the range, such as "192.168.1.100 ~ 150". The rule will control IP addresses from 192.168.1.100 to 150. If all Intranet users that connect with the device are to be controlled, input "0" in the boxes of IP address. This means all Intranet IP addresses will be restricted. QoS can also control the range of Class B.</p>
<p>Direction :</p>	<p>Upstream: Means the upload bandwidth for Intranet IP.</p> <p>Downstream: Means the download bandwidth for Intranet IP.</p> <p>Server in LAN, Upstream: If a Server for external connection has been built in the device, this option is to control the bandwidth for the traffic coming from outside to this Server.</p> <p>Server in LAN, Downstream: If there are web sites built in the Intranet, this option is to control the upload bandwidth for the connections from outside to this Server. For example, game servers have been built in many Internet cafés. This rule can be used to control the bandwidth for connections from outside to the game server of a café to update data. In this way, game players inside the café will not be affected.</p>
<p>Min. & Max. Rate : (Kbit/Sec)</p>	<p>The minimum bandwidth: The rule is to guarantee minimum available bandwidth.</p> <p>The maximum bandwidth: This rule is to restrict maximum available bandwidth. The maximum bandwidth will not exceed the limit set up under this rule.</p> <p>Attention! The unit of calculation used in this rule is Kbit. Some software indicates download/upload speed by the unit KB. 1KB = 8Kbit.</p>

Bandwidth Assign Type :	<p>Sharing total bandwidth with all IP addresses: If this option is selected, all IP addresses or Service Ports will share the bandwidth range (from minimum to maximum bandwidth).</p> <p>Assign bandwidth for each IP address: If this option is selected, every IP or Service Port in this range can have this bandwidth (minimum to maximum). For example, If the rule is set for the IP of each PC, the IP of each PC will have the same bandwidth.</p> <p>Attention: If "Share-Bandwidth" is selected, be aware of the actual usage conditions and avoid an improper configuration that might cause a malfunction of the network when the bandwidth is too small. For example, if users do not want an FTP to occupy too much bandwidth, users can select the "Share-Bandwidth Mode", so that no matter how much users use FTPs to download information, the total occupied bandwidth is fixed.</p>
Enable :	Activate the rule.
Add to list :	Add this rule to the list.
Move up & Move down :	QoS rules will be executed from the bottom of the list to the top of the list. In other words, the lower down the list, the higher the priority of execution. Users can arrange the sequence according to their priorities. Usually the service ports which need to be restricted, such as BT, e-mule, etc., will be moved to the bottom of the list. The rules for certain IP addresses would then be moved upward.
Delete selected items :	Remove the rules selected from the Service List.
Show Table :	Display all the Rate Control Rules users made for the bandwidth. Click " Edit " to modify.
Apply :	Click " Apply " to save the configuration
Cancel :	Click " Cancel " to leave without making any change.

Show Table :

 <input checked="" type="radio"/> Rule <input type="radio"/> Interface <input type="button" value="Refresh"/> <input type="button" value="Close"/> 								
Service Port	IP Address	Direction	Mini. Rate (Kbit/sec)	Max. Rate (Kbit/sec)	Bandwidth Assign Type	Enabled	Interface	Edit

Priority Control :

The Router will distribute the bandwidth as 60% (the highest) and 10% (the lowest). If you set the service port 80 as "High" priority, the router will give 60% bandwidth to the port 80. In the other hand, if you give the port 21 as "Low" priority, the device will only give it 10% bandwidth. The remained 30% bandwidth will be shared by the other service.

Quality of Service

Type : Rate Control Priority

Interface : WAN 1 WAN 2 WAN 3 WAN 4

Service Port :

Direction :

Priority :

Enabled :

Interface :	Select on which WAN the QoS rule should be executed. It can be a single selection or multiple selections.
Service Port :	Select what bandwidth control is to be configured in the QoS rule. If FTP uploads or downloads need to be controlled, select "FTP Port 21~21". Refer to the Default Service Port Number List.

Direction :	<p>Upstream: Means the upload bandwidth for Intranet IP.</p> <p>Downstream: Means the download bandwidth for Intranet IP.</p> <p>Server in LAN, Upstream: If a Server for external connection has been built in the device, this option is to control the bandwidth for the traffic coming from outside to this Server.</p> <p>Server in LAN, Downstream: If there are web sites built in the Intranet, this option is to control the upload bandwidth for the connections from outside to this Server. For example, game servers have been built in many Internet cafés. This rule can be used to control the bandwidth for connections from outside to the game server of a café to update data. In this way, game players inside the café will not be affected.</p>
Priority :	<p>High: 60% guaranteed bandwidth to the service</p> <p>Low: Only 10% bandwidth offered to the service</p>
Enabled :	Activate the rule.
Add to list :	Add this rule to the list.
Delete Selected items :	Remove the rules selected from the Service List.
Show Table :	This will display all the Priority Rules users made for the bandwidth. Click "Edit" to modify.
Apply :	Click " Apply " to save the configuration
Cancel :	Click " Cancel " to leave without making any change.

8.2 Session control

Session management controls the acceptable maximum simultaneous sessions of Intranet PCs. This function is very useful for managing connection quantity when P2P software such as BT, Thunder, or emule is used in the Intranet causing large numbers of sessions. Setting up proper limitations on sessions can effectively control the sessions created by P2P software. It will also have a limiting effect on bandwidth usage.

In addition, if any Intranet PC is attacked by a virus like Worm.Blaster and sends a huge number of session requests, session control will restrict that as well.

Session Control and Scheduling :

Session Control

<input checked="" type="radio"/> Disabled	
<input type="radio"/> Single IP cannot exceed	<input type="text" value="200"/> session
<input type="radio"/> When single IP exceed	<input type="text" value="200"/> ,
<input checked="" type="radio"/>	block this IP's new sessions for <input type="text" value="5"/> minutes
<input type="radio"/>	block this IP's all sessions for <input type="text" value="5"/> minutes

Scheduling

Apply this rule	Always	<input type="text" value="0"/> : <input type="text" value="0"/> to <input type="text" value="0"/> : <input type="text" value="0"/>	(24-Hour Format)
<input type="checkbox"/> Everyday	<input type="checkbox"/> Sun	<input type="checkbox"/> Mon	<input type="checkbox"/> Tue
	<input type="checkbox"/> Wed	<input type="checkbox"/> Thu	<input type="checkbox"/> Fri
		<input type="checkbox"/> Sat	

Disabled :	Disable Session Control function.
Single IP cannot exceed ___ session :	This option enables the restriction of maximum external sessions to each Intranet PC. When the number of external sessions reaches the limit, to allow new sessions to be built, some of the existing sessions must be closed. For example, when BT or P2P is being used to download information and the sessions exceed the limit, the user will be unable to connect with other services until either BT or P2P is closed.

<p>When single IP exceed ___ :</p>	<p><input checked="" type="radio"/> block this IP to add new session for <input type="text" value="5"/> Minutes</p> <p>If this function is selected, when the user's port session reach the limit, this user will not be able to make a new session for five minutes. Even if the previous session has been closed, new sessions cannot be made until the setting time ends.</p> <p><input type="radio"/> block this IP's all connection for <input type="text" value="5"/> Minutes</p> <p>If this function is selected, when the user's port connections reach the limit, all the lines that this user is connected with will be removed, and the user will not be able to connect with the Internet for five minutes. New connections cannot be made until the delay time ends.</p>
<p>Scheduling :</p>	<p>If "Always" is selected, the rule will be executed around the clock.</p> <p>If "From..." is selected, the rule will be executed according to the configured time range. For example, if the time control is from Monday to Friday, 8:00am to 6:00pm, users can refer to the following figure to set up the rule.</p>
<p>Apply :</p>	<p>Click "Apply" to save the configuration.</p>
<p>Cancel :</p>	<p>Click "Cancel" to leave without making any change.</p>

Exempted Service Port or IP Address

Exempted Service Port or IP Address

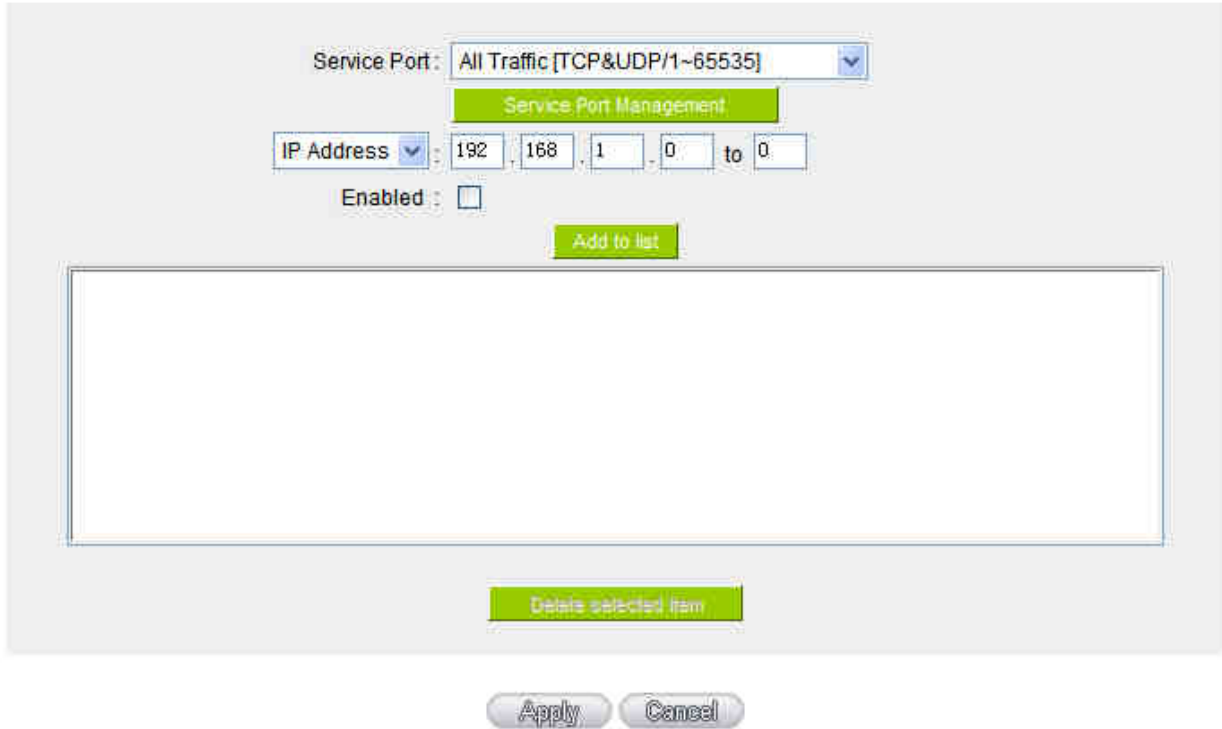

Service Port :	Choose the service port.
IP Address :	Input the IP address range or IP group.
Enabled :	Activate the rule.
Add to list :	Add this rule to the list.
Delete seleted item :	Remove the rules selected from the Service List.
Apply :	Click " Apply " to save the configuration.
Cancel :	Click " Cancel " to leave without making any change.

Enabled Penalty Mechanism	To activate the penalty mechanism.
Show Penalty List	To show the IPs with upstream constraint & downstream constraint and in the penalty mechanism.
Applied Time	If "Always" is selected, the rule will be executed around the clock. If "From..." is selected, the rule will be executed according to the configured time range.

IX. Firewall

This chapter introduces firewall general policy, access rule, and content filter settings to ensure network security.

9.1 General Policy

The firewall is enabled by default. If the firewall is set as disabled, features such as SPI, DoS, and outbound packet responses will be turned off automatically. Meanwhile, the remote management feature will be activated. The network access rules and content filter will be turned off.

Firewall :	<input checked="" type="radio"/> Enabled <input type="radio"/> Disabled
SPI (Stateful Packet Inspection) :	<input checked="" type="radio"/> Enabled <input type="radio"/> Disabled
DoS (Denial of Service) :	<input checked="" type="radio"/> Enabled <input type="radio"/> Disabled Advanced
Block WAN Request :	<input type="radio"/> Enabled <input checked="" type="radio"/> Disabled
Remote Management :	<input type="radio"/> Enabled <input checked="" type="radio"/> Disabled Port: <input type="text" value="80"/>
Multicast Pass Through :	<input type="radio"/> Enabled <input checked="" type="radio"/> Disabled
Prevent ARP Virus Attack :	<input type="radio"/> Enabled <input checked="" type="radio"/> Disabled Router sends ARP <input type="text" value="20"/> times per-second.

Restrict WEB Features

Block :	<input type="checkbox"/> Java
	<input type="checkbox"/> Cookies
	<input type="checkbox"/> ActiveX
	<input type="checkbox"/> Access to HTTP Proxy Servers

Don't block Java/ActiveX/Cookies/Proxy to Trusted Domains

Firewall :	This feature allows users to turn on/off the firewall.
-------------------	--

<p>SPI (Stateful Packet Inspection) :</p>	<p>This enables the packet automatic authentication detection technology. The Firewall operates mainly at the network layer. By executing the dynamic authentication for each connection, it will also perform an alarming function for application procedure. Meanwhile, the packet authentication firewall may decline the connections which use non-standard communication protocol.</p>
<p>DoS (Denial of Service) :</p>	<p>This averts DoS attacks such as SYN Flooding, Smurf, LAND, Ping of Death, IP Spoofing and so on.</p>
<p>Block WAN request :</p>	<p>If set as Enabled, then it will shut down outbound ICMP and abnormal packet responses in connection. If users try to ping the WAN IP from the external, this will not work because the default value is set as activated in order to decline the outbound responses.</p>
<p>Remote Management :</p>	<p>To enter the device web- based UI by connecting to the remote Internet, this feature must be activated. In the field of remote browser IP, a valid external IP address (WAN IP) for the device should be filled in and the modifiable default control port should be adjusted (the default is set to 80, modifiable).</p>
<p>Multicast Pass Through :</p>	<p>There are many audio and visual streaming media on the network. Broadcasting may allow the client end to receive this type of packet message format. This feature is off by default.</p>
<p>Prevent ARP Virus Attack :</p>	<p>This feature is designed to prevent the intranet from being attacked by ARP spoofing, causing the connection failure of the PC. This ARP virus cheat mostly occurs in Internet cafes. When attacked, all the online computers disconnect immediately or some computers fail to go online. Activating this feature may prevent the attack by this type of virus.</p>

Advanced Setting

PacketType	WAN Threshold	LAN Threshold
<input type="checkbox"/> TCP_SYN_Flooding	Threshold counted by all packets: 15000 Packets/sec	Threshold counted by all packets: 15000 Packets/sec
	Threshold counted by single IP packet: 2000 Packets/sec	Single Dest. IP Threshold: 2000 Packets/sec
	Block this IP when reach threshold: 5 minutes	Block this IP when reach threshold: 5 minutes
<input checked="" type="checkbox"/> UDP_Flooding	Threshold counted by all packets: 15000 Packets/sec	Threshold counted by all packets: 15000 Packets/sec
	Threshold counted by single IP packet: 2000 Packets/sec	Single Source IP Threshold: 2000 Packets/sec
	Block this IP when reach threshold: 5 minutes	Block this IP when reach threshold: 5 minutes
<input checked="" type="checkbox"/> ICMP_Flooding	Threshold counted by all packets: 200 Packets/sec	Threshold counted by all packets: 200 Packets/sec
	Threshold counted by single IP packet: 50 Packets/sec	Single Source IP Threshold: 50 Packets/sec
	Block this IP when reach threshold: 5 minutes	Block this IP when reach threshold: 5 minutes
<input type="checkbox"/> Exempted Source IP	1. IP Address: 0 0 0 0 0	
	2. IP Address: 0 0 0 0 0	
<input type="checkbox"/> Exempted Dest. IP	1. 0 0 0 0	
	2. 0 0 0 0	
	3. 0 0 0 0	
	4. 0 0 0 0	
	5. 0 0 0 0	

Packet Type: This device provides three types of data packet transmission: TCP-SYN-Flood, UDP-Flood and ICMP-Flood.

WAN Threshold: When all packet values from external attack or from single external IP attack reach the maximum amount (the default is 15000 packets/Sec and 2000 packets/Sec respectively), if these conditions above occurs, the IP will be blocked for 5 minutes (the default is 5 minutes OBJ 176). Users can adjust the threshold value and the blocking duration to effectively deal with external attack. The threshold value should be adjusted from high to low.

LAN Threshold: When all packet values from internal attack or from single internal IP attack reach the maximum amount (the default is 15000 packets/Sec and 2000 packets/Sec respectively), if these conditions above occurs, the IP will be blocked for 5 minutes (the default is 5 minutes). Users can adjust the threshold value and the blocking duration to effectively deal with external attack. The threshold value should be adjusted from high to low.

Exempted Source IP :	Input the exempted source IP.
Exempted Dest. IP :	Input the exempted Destination IP addresses.

Show Blocked IP :	 <p>Show the blocked IP list and the remained blocked time.</p>
Restricted WEB Features :	It supports the block that is connected through: Java, Cookies, Active X, and HTTP Proxy access.
Don't Block Java / ActiveX / Cookies Proxy to Trusted Domain :	If this option is activated, users can add trusted network or IP address into the trust domain, and it will not block items such as Java/ActiveX/Cookies contained in the web pages from the trust domains.
Apply :	Click " Apply " to save the configuration.
Cancel :	Click " Cancel " to leave without making any change.

9.2 Restrict Application

Users can check **MSN/ Skype/ QQ/ BT** and the device will block the service users checked. However, to provide this service for certain IP address in the intranet, users may check the following item and then enter the specific IP address or IP address session to use the services which are checked above.

Restrict Application

Block :	<input type="checkbox"/> MSN
	<input type="checkbox"/> Skype
	<input type="checkbox"/> QQ Exempted QQ Number
	<input type="checkbox"/> BT

Exempted IP Address :	<input type="checkbox"/> 192 . 168 . 0 . 0 to 254
	<input type="checkbox"/> 192 . 168 . 0 . 0 to 254
	<input checked="" type="checkbox"/> 192 . 168 . 0 . 0 to 254
	<input type="checkbox"/> 192 . 168 . 0 . 0 to 254
	<input type="checkbox"/> 192 . 168 . 0 . 0 to 254

In addition, if Blocked QQ is activated, users can set the exempted QQ number list. Press "Exempted QQ Number" button, and enter the QQ number into the exempted QQ number list.

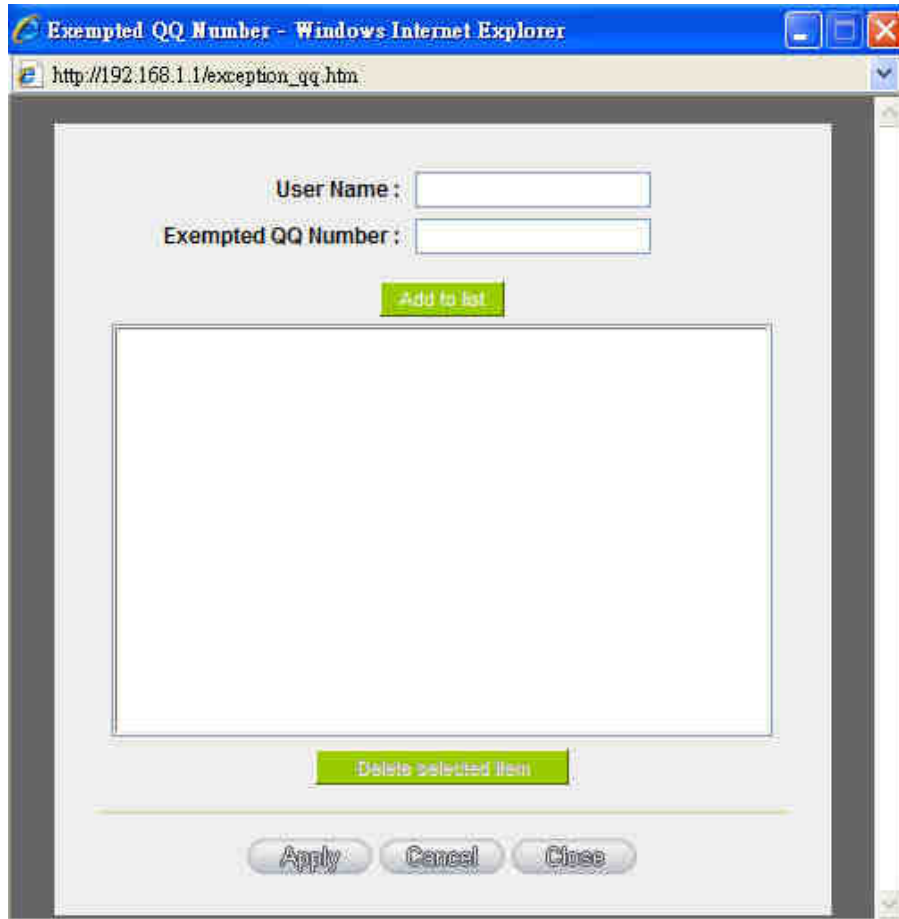

User Name :	Input the information of the QQ number, etc.
Exempted QQ Number :	Input the number.
Add to list :	Add the number to the list.
Delete selected item :	Delete the selected rule in the list.

9.3 Access Rule

Users may turn on/off the setting to permit or forbid any packet to access internet. Users may select to set different network access rules: from internal to external or from external to internal. Users may set different packets for IP address and communication port numbers to filter Internet access rules.

Network access rule follows IP address, destination IP address, and IP communications protocol status to manage the network packet traffic and make sure whether their access is allowed by the firewall.

The device has a user-friendly network access regulatory tool. Users may define network access rules. They can select to enable/ disable the network so as to protect all internet access. The following describes the internet access rules:

- All traffic from the LAN to the WAN is allowed - by default.
- All traffic from the WAN to the LAN is denied - by default.
- All traffic from the LAN to the DMZ is allowed - by default.
- All traffic from the DMZ to the LAN is denied - by default.
- All traffic from the WAN to the DMZ is allowed - by default.
- All traffic from the DMZ to the WAN is allowed - by default.

Users may define access rules and do more than the default rules. However, the following four extra service items are always on and are not affected by other user-defined settings.

* HTTP Service (from LAN to Device) is on by default (for management)

* DHCP Service (from LAN to Device) is set to on by default (for the automatic IP retrieval)

* DNS Service (from LAN to Device) is on by default (for DNS service analysis)

* Ping Service (from LAN to Device) is on by default (for connection and test)

Jump to / 2 Page entries per page [Next Page>>](#)

Priority	Enabled	Action	Service Port	Interface	Source IP	Dest. IP	Control Time	Day	Edit	Delete
	<input checked="" type="checkbox"/>	Allow	All Traffic [*]	LAN	Any	Any	Always			
	<input checked="" type="checkbox"/>	Deny	All Traffic [*]	WAN1	Any	Any	Always			
	<input checked="" type="checkbox"/>	Deny	All Traffic [*]	WAN2	Any	Any	Always			
	<input checked="" type="checkbox"/>	Deny	All Traffic [*]	WAN3	Any	Any	Always			
	<input checked="" type="checkbox"/>	Deny	All Traffic [*]	WAN4	Any	Any	Always			

In addition to the default rules, all the network access rules will be displayed as illustrated above. Users may follow or self-define the priority of each network access rule. The device will follow the rule priorities one by one, so please make sure the priority for all the rules can suit the setting rules.

Edit :	Define the network access rule item
Delete :	Remove the item.
Add New Rule :	Create a new network access rule
Return to Default Rule :	Restore all settings to the default values and delete all the self-defined settings.

9.3.2 Add New Access Rule

Access Rule

Action :	Allow
Service Port :	All Traffic [TCP&UDP/1~65535] Service Port Management
Log :	No log
Interface :	LAN
Source IP :	Single []-[]-[]-[]
Dest. IP :	Single []-[]-[]-[]

Scheduling

Apply this rule	Always	[] : [] to [] : [] (24-Hour Format)
<input type="checkbox"/> Everyday	<input type="checkbox"/> Sun	<input type="checkbox"/> Mon
<input type="checkbox"/> Tue	<input type="checkbox"/> Wed	<input type="checkbox"/> Thu
<input type="checkbox"/> Fri	<input type="checkbox"/> Sat	

Action :	<p>Allow: Permits the pass of packets compliant with this control rule</p> <p>Deny: Prevents the pass of packets not compliant with this control rule</p>
Service Port :	From the drop-down menu, select the service that users grant or do not give permission.
Service Port Management :	<p>If the service that users wish to manage does not exist in the drop-down menu, press – Service Management to add the new service.</p> <p>From the pop-up window, enter a service name and communications protocol and port, and then click the “Add to list” button to add the new service.</p>
Log :	<p>No Log : There will be no log record.</p> <p>Create Log when matched : Event will be recorded in the log.</p>
Interface :	Select the source port whether users are permitted or not (for example: LAN, WAN1, WAN2 or Any). Select from the drop-down

	menu.
Source IP :	Select the source IP range (for example: Any, Single, Range, or preset IP group name). If Single or Range is selected, please enter a single IP address or an IP address within a session.
Dest. IP :	Select the destination IP range (such as Any, Single, Range, or preset IP group name) If Single or Range is selected; please enter a single IP address or an IP address within a session.
Scheduling :	Select " Always " to apply the rule on a round-the-clock basis. Select " from ", and the operation will run according to the defined time.
Apply this rule :	Select " Always " to apply the rule on a round-the-clock basis. If " From " is selected, the activation time is introduced as below
... to ... :	This control rule has time limitation. The setting method is in 24-hour format, such as 08:00 ~ 18:00 (8 a.m. to 6 p.m.)
Day Control :	" Everyday " means this period of time will be under control everyday. If users only certain days of a week should be under control, users may select the desired days directly.
Apply :	Click " Apply " to save the configuration.
Cancel :	Click " Cancel " to leave without making any change.

9.4 Content Filter

The device supports two webpage restriction modes: one is to block certain forbidden domains, and the other is to give access to certain web pages. Only one of these two modes can be selected.

- Accept Allowed Domains
- Block Forbidden Domains

Allowed Domains

Enabled

Block Forbidden Domain

Fill in the complete website such as www.sex.com to have it blocked.

- Accept Allowed Domains
- Block Forbidden Domains

Forbidden Domains

Enabled

Domain Name :

Exempted IP Address : to

Domain Name :	Enter the websites to be controlled such as www.playboy.com
Add to list :	Click "Add to list" to create a new website to be controlled.
Delete selected item :	Click to select one or more controlled websites and click this option to delete.

Website Blocking by Keywords :

Website Blocking by Keywords

Enabled

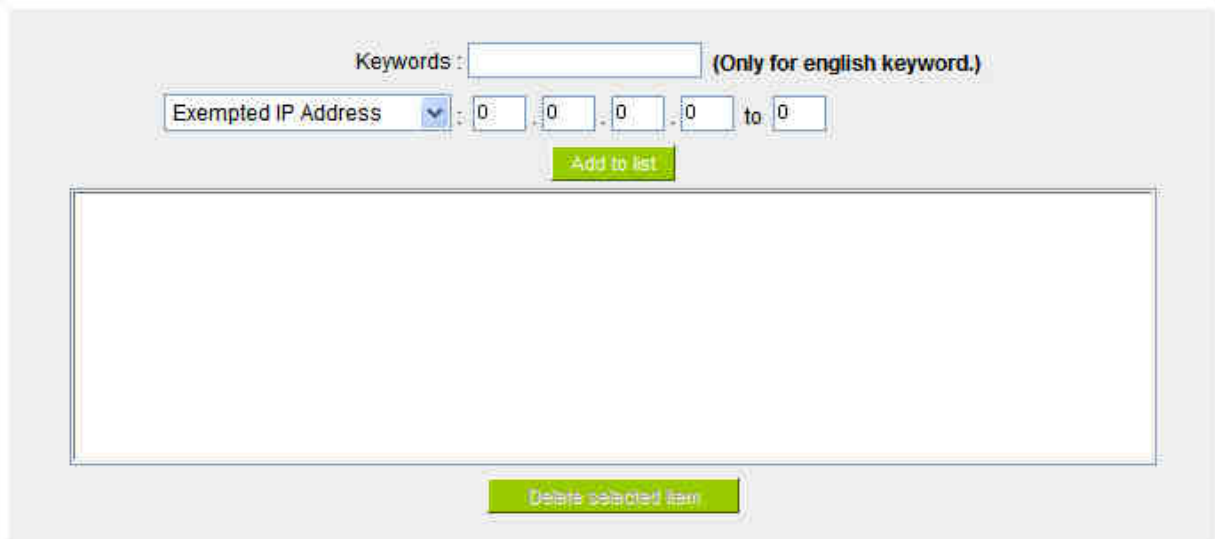

Keywords : (Only for english keyword.)

Exempted IP Address : . . . to

Enabled :	Click to activate this feature. The default setting is disabled. For example: If users enter the string "sex", any websites containing "sex" will be blocked.
Keywords (Only for English keyword) :	Enter keywords.
Add to List :	Add this new service item content to the list.
Delete selected item :	Delete the service item content from the list
Apply :	Click "Apply" to save the modified parameters.
Cancel :	Click "Cancel" to cancel all the changes made to the parameters.

Accept Allowed Domains

In some companies or schools, employees and students are only allowed to access some specific websites. This is the purpose of the function.

- Accept Allowed Domains
- Block Forbidden Domains

Allowed Domains

Enabled

Domain Name :

Enabled :	Activate the function. The default setting is "Disabled."
Domain Name :	Input the allowed domain name, etc. www.google.com
Add to list :	Add the rule to list.
Delete selected item :	Users can select one or more rules and click to delete.

Content Filter Scheduling

Select **"Always"** to apply the rule on a round-the-clock basis. Select **"from"**, and the operation will run according to the defined time. For example, if the control time runs from 8 a.m. to 6 p.m., Monday to Friday, users may control the operation according to the following illustrated example.

Scheduling

Apply this rule Always : : to : (24-Hour Format)

Everyday
 Sun
 Mon
 Tue
 Wed
 Thu
 Fri
 Sat

Always :	Select " Always " to apply the rule on a round-the-clock basis. Select " from ", and the operation will run according to the defined time.
...to... :	Select " Always " to apply the rule on a round-the-clock basis. If " From " is selected, the activation time is introduced as below
Day Control :	This control rule has time limitation. The setting method is in 24-hour format, such as 08:00 ~ 18:00 (8 a.m. to 6 p.m.)

X. VPN (Virtual Private Network)

10.1. VPN

VPN

- ▶ Summary
- Gateway to Gateway
- Client to Gateway
- PPTP Setup
- PPTP Status
- VPN Pass Through

PPTP Tunnel Number : Tunnel(s) Used Tunnel(s) Available
 IPsec + QnoKey Tunnel Number : Tunnel(s) Used Tunnel(s) Available [Advanced](#)
 IPsec VPN Tunnel Number : Tunnel(s) Used Tunnel(s) Available [Detail](#)

▶ VPN Tunnel Status

Tunnel(s) Enabled Tunnel(s) Defined

Jump to / 1Page entries per page

No.	Account ID	Status	Phase2 Encrypt/Auth/DH	Local Group	Remote Group	Remote Gateway	Control	Config.
-----	------------	--------	---------------------------	----------------	-----------------	-------------------	---------	---------

[Add New Tunnel](#)

▶ VPN Group Tunnel Status

Group Name	Connected Tunnels	Phase2 Encrypt/Auth/DH	Local Group	Remote Client	Remote Client Status	Control	Config.
------------	----------------------	---------------------------	----------------	------------------	-------------------------	---------	---------

10.1.1. Display All VPN Summary

This VPN Summary displays the real-time data with regard to VPN status. These data include: all tunnel numbers (PPTP, IPsec + QnoKey and IPsec VPN), setting parameters and Group VPN and so forth.

Advanced Setting : Through Advanced setting, users may adjust the tunnel number of IPSec and QnoKey.

PPTP Tunnel Number :	<input type="text" value="0"/>	Tunnel(s) Used	<input type="text" value="30"/>	Tunnel(s) Available	<input type="button" value="Advanced"/> <input type="button" value="Detail"/>
IPSec + QnoKey Tunnel Number :	<input type="text" value="0"/>	Tunnel(s) Used	<input type="text" value="200"/>	Tunnel(s) Available	
IPSec VPN Tunnel Number :	<input type="text" value="0"/>	Tunnel(s) Used	<input type="text" value="150"/>	Tunnel(s) Available	

This shows how many VPN tunnels are in use or available.

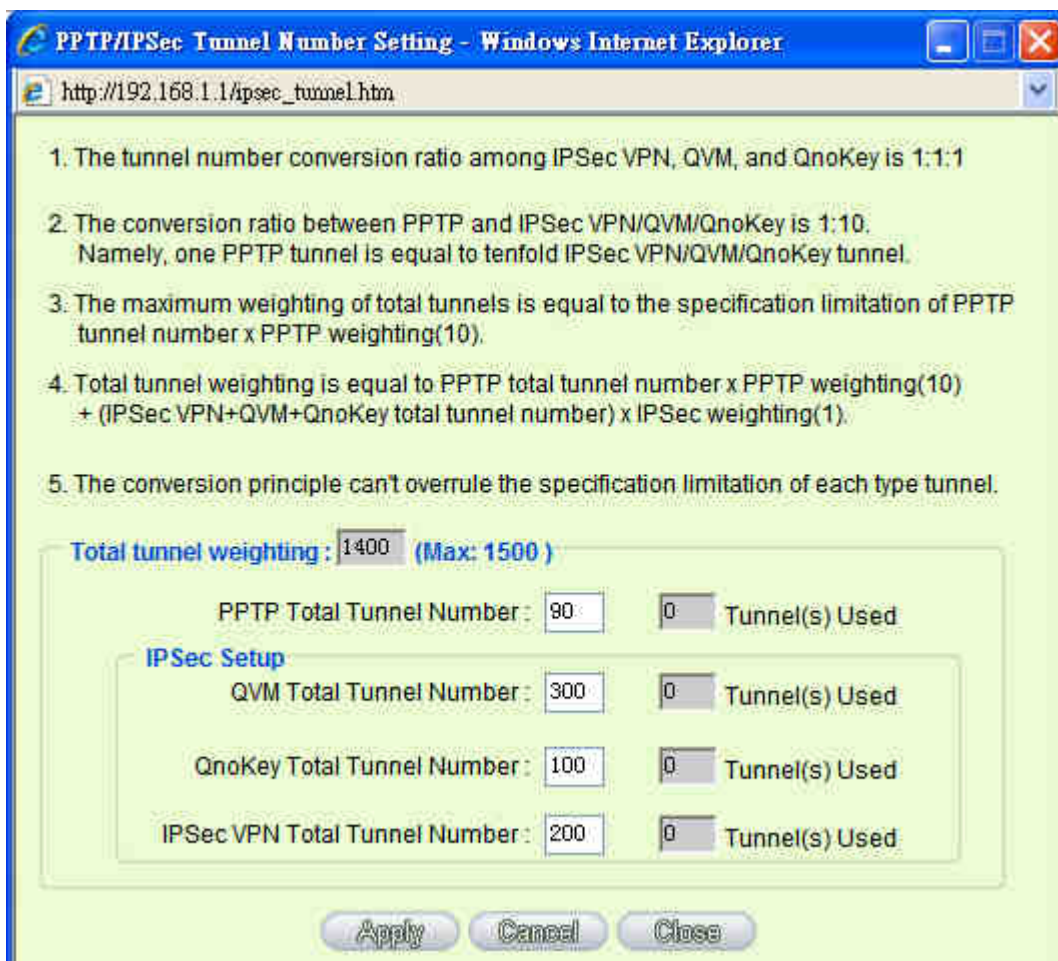

Detail : Push this button to display the following information with regard to all current VPN configurations to facilitate VPN connection management.

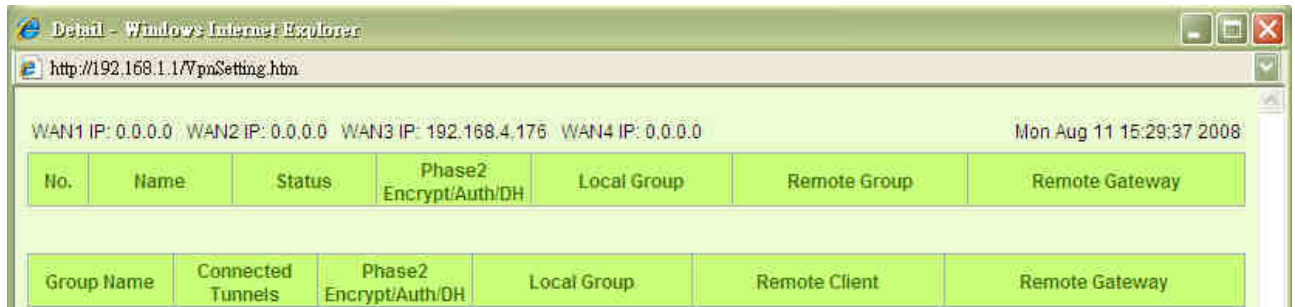

VPN Tunnel Status :

The following describes VPN Tunnel Status, the current status of VPN tunnel in detail :



▶ VPN Tunnel Status

Tunnel(s) Enabled Tunnel(s) Defined

Jump to / 1Page entries per page

No.	Account ID	Status	Phase2 Encrypt/Auth/DH	Local Group	Remote Group	Remote Gateway	Control	Config.
<input type="button" value="Add New Tunnel"/>								

Previous Page/Next Page, Jump to ___/___ Page, ___ Entries Per Page	Click Previous page or Next page to view the desired VPN tunnel page. Or users can select the page number directly to view all VPN tunnel statuses, such as 3, 5, 10, 20 or All.
Tunnel No.	To set the embedded VPN feature, please select the tunnel number. It supports up to 300 IPsec VPN tunnel Setting (gateway to gateway as well as client to gateway).
Status :	Successful connection is indicated as-(Connected). Failing hostname resolution is indicated as - (Hostname Resolution Failed). Resolving hostname is indicated as -(Resolving Hostname) Waiting to be connected is indicated as - (Waiting for Connection). If users select Manual setting for IPsec setup, the status message will display as "Manual" and there is no Tunnel test function available for this manual setting.



Account ID :	<p>Displays the current VPN tunnel connection name, such as XXX Office. Users are well-advised to give them different names to avoid confusion should users have more than one tunnel settings.</p> <p>Note: If this tunnel is to be connected to other VPN device (not this device), some device requires that the tunnel name is identical to the name of the host end to facilitate verification. This tunnel can thus be successfully enabled.</p>
Phase2 Encrypt/Auth/Group :	<p>Displays settings such as encryption (DES/3DES), authentication (MD5/SHA1) and Group (1/2/5). If users select Manual setting for IPSec, Phase 2 DH group will not display.</p>
Local Group :	<p>Displays the setting for VPN connection secure group of the local end.</p>
Remote Group :	<p>Displays the setting for remote VPN connection secure group.</p>
Remote Gateway :	<p>Set the IP address to connect the remote VPN device. Please set the VPN device with a valid IP address or domain name.</p>
Control :	<p>Click "Connect" to verify the tunnel status. The test result will be updated. To disconnect, click "Disconnect" to stop the VPN connection.</p>
Config :	<p>Setting items include Edit and Delete icon. </p> <p>Click on Edit to enter the setting items and users may change the settings. Click on the trash bin icon  and all the tunnel settings will be deleted.</p>
<p>__ Tunnel(s) Enabled:</p> <p>__ Tunnel(s) Defined:</p>	<p>This displays how many tunnels are enabled and how many tunnels are set.</p>

VPN Group Tunnel Status :

If there is no setting for Group VPN, there will be no display of VPN Group status.

VPN Group Tunnel Status

Group Name	Connected Tunnels	Phase2 Encrypt/Auth/DH	Local Group	Remote Client	Remote Client Status	Control	Config.
------------	-------------------	------------------------	-------------	---------------	----------------------	---------	---------

Group Name :	Displays the tunnel name of the Group VPN that is connected.
Connected Tunnels :	Displays the VPN Groups tunnel numbers.
Phase2 Encrypt/Auth/DH :	Displays settings such as encryption (DES/3DES), authentication (MD5/SHA1) and Group (1/2/5). If users select Manual setting for IPSec, Phase 2 DH group will not be displayed.
Local Group :	Displays the VPN connection secure setting for the local group.
Remote Client :	Displays the name of this group for remote VPN Connection secure group setting.
Remote Client Status :	Click on Detail List , and more information such as Group Name, IP address and the connection time will be displayed.
Control :	Click Connect to verify the status of the tunnel. The test result will be updated in this status.
Config :	As illustrated below, configurations include Edit and Delete  icon. Click on Edit to enter the setting items to be changed. Click on the trash bin icon  , and all the tunnel settings will be deleted.

10.1.2. Add a New VPN Tunnel

The device supports Gateway to Gateway tunnel or Client to Gateway tunnel.

The VPN tunnel connections are done by 2 VPN devices via the Internet. When a new tunnel is added, the setting page for Gateway to Gateway or Client to Gateway will be displayed.

Gateway to Gateway :

Click "Add" to enter the setting page of Gateway to Gateway.

[Gateway to Gateway](#)



Client to Gateway :

Click "Add" to enter the setting page of Client to Gateway.

[Client to Gateway](#)



10.1.2.1. Gateway to Gateway Setting

Tunnel No.:	1
Tunnel Name:	
Interface:	WAN 1
Enabled:	<input checked="" type="checkbox"/>

The following instructions will guide users to set a VPN tunnel between two devices.



Tunnel No. :	Set the embedded VPN feature, please select the Tunnel number.
Tunnel Name :	Displays the current VPN tunnel connection name, such as XXX Office. Users are well-advised to give them different names to avoid confusion. Note: If this tunnel is to be connected to the other VPN device, some device requires that the tunnel name is identical to the name of the host end to facilitate verification. This tunnel can thus be successfully enabled.
Interface :	From the pull-down menu, users can select the Interface for this VPN tunnel.
Enabled :	Click to activate the VPN tunnel. This option is set to activate by default. Afterwards, users may select to activate this tunnel feature.

Local Group Setup :

Local Group Setup

Local Security Gateway Type:	IP Only
IP Address:	192 . 168 . 4 . 123
Local Security Group Type:	Subnet
IP Address:	192 . 168 . 1 . 0
Subnet Mask:	255 . 255 . 255 . 0

This Local Security Gateway Type must be identical with that of the remote type (Remote Security Gateway Type).

<p>Local Security GatewayType :</p>	<p>This local gateway authentication type comes with five operation modes, which are: IP only IP + Domain Name (FQDN) Authentication IP + E-mail Addr. (USER FQDN) Authentication Dynamic IP + Domain Name (FQDN) Authentication Dynamic IP + E-mail Addr. (USER FQDN) Authentication. Dynamic IP address + Email address name</p> <p>(1) IP only:</p> <p>If users decide to use IP only, entering the IP address is the only way to gain access to this tunnel. The WAN IP address will be automatically filled into this space. Users don't need to do further settings.</p>  <p>(2) IP + Domain Name(FQDN) Authentication:</p> <p>If users select IP + domain name type, please enter the domain name and IP address. The WAN IP address will be automatically filled into this space. Users don't need to do further settings. FQDN refers to the combination of host name and domain name and can be retrieved from the Internet, i.e. vpn.server.com. This IP address and domain name must be identical to those of the VPN secure gateway setting type to establish successful connection.</p>  <p>(3) IP + E-mail Addr. (USER FQDN) Authentication.</p> <p>If users select IP address and E-mail, enter the IP address and E-mail address to gain access to this tunnel and the WAN IP address will be automatically filled into this space. Users don't</p>
-------------------------------------	---

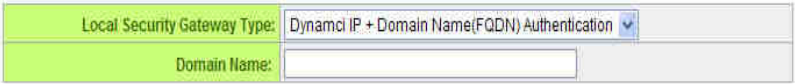
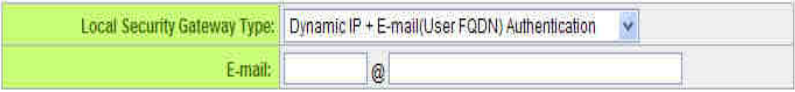
	<p>need to do further settings.</p>  <p>(4) Dynamic IP + Domain Name(FQDN) Authentication:</p> <p>If users use dynamic IP address to connect to the device, users may select this option to link to VPN. If the remote VPN gateway requires connection to the device for VPN connection, this device will start authentication and respond to this VPN tunnel connection; if users select this option to link to VPN, please enter the domain name.</p>  <p>(5) Dynamic IP + E-mail Addr. (USER FQDN) Authentication.</p> <p>If users use dynamic IP address to connect to the device, users may select this option to connect to VPN without entering IP address. When VPN Gateway requires for VPN connection, the device will start authentication and respond to VPN tunnel connection; If users select this option to link to VPN, enter E-Mail address to the empty field for E-Mail authentication.</p> 
<p>Local Security Group Type :</p>	<p>This option allows users to set the local VPN connection access type. The following offers a few items for local settings. Please select and set appropriate parameters:</p> <ol style="list-style-type: none"> IP address This option allows the only IP address which is entered to

build the VPN tunnel.

Local Security Group Type:	IP Address
IP Address:	192 . 168 . 1 . 0

Reference: When this VPN tunnel is connected, computers with the IP address of 192.168.1.0 can establish connection.

2. Subnet

This option allows local computers in this subnet can be connected to the VPN tunnel.

Local Security Group Type:	Subnet
IP Address:	192 . 168 . 1 . 0
Subnet Mask:	255 . 255 . 255 . 0

Reference: When this VPN tunnel is connected, only computers with the session of 192.168.1.0 and with subnet mask as 255.255.255.0 can connect with remote VPN.

3. IP Range

This option allows connection only when IP address range which is entered after the VPN tunnel is connected.

Local Security Group Type:	IP Range
IP Range:	192 . 168 . 1 . 0 to 254



Reference: When this VPN tunnel is connected, computers with the IP address of 192.168.1.0 ~254 can establish connection.

Remote Group Setup :

Remote Group Setup

Remote Security Gateway Type:	IP Only
IP Address	
Remote Security Group Type:	Subnet
IP Address:	
Subnet Mask:	255 . 255 . 255 . 0

This remote gateway authentication type (Remote Security Gateway Type) must be identical to the remotely-connected local security gateway authentication type (Local Security Gateway Type).

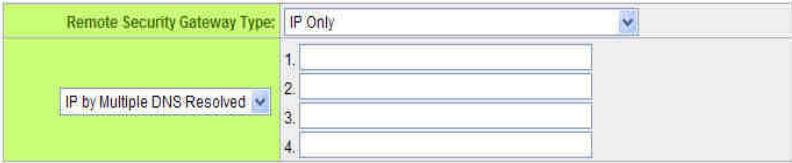
<p>Remote Security Gateway Type :</p>	<p>This remote gateway authentication type comes with five operation modes, which are:</p> <p>IP only-Authentication by use of IP only IP + Domain Name (FQDN) Authentication, -IP + Domain name IP + E-mail Addr. (USER FQDN) Authentication, -IP + Email address Dynamic IP + Domain Name (FQDN) Authentication, -Dynamic IP address + Domain name Dynamic IP + E-mail Addr. (USER FQDN) Authentication. Dynamic IP address + Email address name</p> <p>(1) IP only:</p> <p>If users select the IP Only type, entering this IP allows users to gain access to this tunnel.</p>  <p>If the IP address of the remote client is unknown, choose IP by DNS Resolved, allowing DNS to translate IP address. When users finish the setting, the corresponding IP address will be displayed under the remote gateway of Summary.</p>  <p>Or users can choose IP by Multiple DNS Resolved, and IP address can be translated through DNS. When users finish the setting, the corresponding IP address will be displayed under the remote gateway of Summary.</p> 
---------------------------------------	--

(2) IP + Domain Name(FQDN) Authentication:

If users select IP + domain name, please enter IP address and the domain name to be verified. FQDN refers to the combination of host name and domain name. Users may enter any name that corresponds to the domain name of FQDN. This IP address and domain name must be identical to those of the remote VPN security gateway setting type to establish successful connection.

Remote Security Gateway Type:	IP + Domain Name(FQDN) Authentication
IP Address:	<input type="text"/>
Domain Name:	<input type="text"/>

If the remote IP address is unknown, choose IP by DNS Resolved, allowing DNS to translate the IP address. This domain name must be available on the Internet. When users finish the setting, the corresponding IP address will be displayed under the remote gateway of Summary.

Remote Security Gateway Type:	IP + Domain Name(FQDN) Authentication
IP by DNS Resolved	<input type="text"/>
Domain Name:	<input type="text"/>

Or users can choose IP by Multiple DNS Resolved, and IP address can be translated through DNS. When users finish the setting, the corresponding IP address will be displayed under the remote gateway of Summary.

Remote Security Gateway Type:	IP + Domain Name(FQDN) Authentication								
IP by Multiple DNS Resolved	<table border="1"> <tr><td>1.</td><td><input type="text"/></td></tr> <tr><td>2.</td><td><input type="text"/></td></tr> <tr><td>3.</td><td><input type="text"/></td></tr> <tr><td>4.</td><td><input type="text"/></td></tr> </table>	1.	<input type="text"/>	2.	<input type="text"/>	3.	<input type="text"/>	4.	<input type="text"/>
1.	<input type="text"/>								
2.	<input type="text"/>								
3.	<input type="text"/>								
4.	<input type="text"/>								
Domain Name:	<input type="text"/>								

(3) IP + E-mail Addr. (USER FQDN) Authentication:

	Remote Security Gateway Type: Dynamic IP + Domain Name(FQDN) Authentication
	Domain Name: <input type="text"/>
<p>(5) Dynamic IP + E-mail Addr. (USER FQDN) Authentication.</p> <p>If users use dynamic IP address to connect with the device, users may select this type to link to VPN. When the remote VPN gateway requires connection to facilitate VPN connection, the device will start authentication and respond to the VPN tunnel connection; Please enter the E-Mail to the empty space.</p>	
	Remote Security Gateway Type: Dynamic IP + E-mail(User FQDN) Authentication
	E-mail: <input type="text"/> @ <input type="text"/>

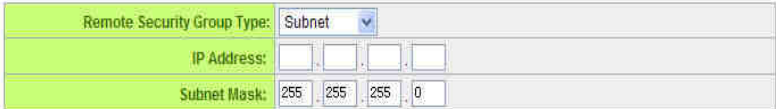
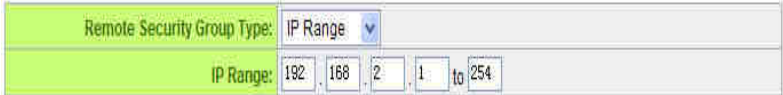
<p>Remote Security Group Type :</p>	<p>This option allows users to set the remote VPN connection access type. The following offers a few items for remote settings. Please select and set appropriate parameters:</p> <p>(1) IP address</p> <p>This option allows the only IP address which is entered to build the VPN tunnel.</p>  <p>Reference: When this VPN tunnel is connected, computers with the IP address of 192.168.2.1 can establish connection.</p> <p>(2) Subnet</p> <p>This option allows local computers in this subnet can be connected to the VPN tunnel.</p>  <p>Reference: When this VPN tunnel is connected, only computers with the session of 192.168.2.0 and with subnet mask as 255.255.255.0 can connect with remote VPN.</p> <p>(3) IP Address Range</p> <p>This option allows connection only when IP address range which is entered after the VPN tunnel is connected.</p>  <p>Reference: When this VPN channel is connected, computers with the IP address range between 192.168.2.1 and 192.168.1.254 can establish connection.</p>
-------------------------------------	--

IPSec Setup

If there is any encryption mechanism, the encryption mechanism of these two VPN

tunnels must be identical in order to create connection. And the transmission data must be encrypted with IPSec key, which is known as the encryption "key". The device provides the following two encrypted Key Managements. They are Manual and IKE automatic encryption mode- IKE with Preshared Key (automatic). By using the drop down menu, select the desired encryption mode as illustrated below.

IPSec Setup

Key Exchange:	Manual
Incoming SPI:	<input type="text"/>
Outgoing SPI:	<input type="text"/>
Encryption:	DES
Authentication:	MD5
Encryption Key:	<input type="text"/>
Authentication Key:	<input type="text"/>

Encryption Management Protocol :

When users set this VPN tunnel to use any encryption and authentication mode, users must set the parameter of this exchange password with that of the remote. Setting methods include Auto (IKE) or Manual. To do the settings, select any one from the two options.

IPSec Setup

Key Exchange:	IKE with Preshared Key
Phase1 DH Group:	Group 1
Phase1 Encryption:	DES
Phase1 Authentication:	MD5
Phase1 SA Life Time:	28800 Seconds
Perfect Forward Secrecy	<input checked="" type="checkbox"/>
Phase2 DH Group:	Group 1
Phase2 Encryption:	DES
Phase2 Authentication:	MD5
Phase2 SA Life Time:	3600 Seconds
Preshared Key:	

[Advanced +](#)

Use IKE Protocol :

Click the shared key generated by IKE to encrypt and authenticate the remote user. If PFS (Perfect Forward Secrecy) is enabled, the Phase 2 shared key generated during the IKE coordination will conduct further encryption and authentication. When PFS is enabled, hackers using brute force to capture the key will not be able to get the Phase 2 key in such a short period of time.

- **Perfect Forward Secrecy:** When users check the PFS option, don't forget to activate the PFS function of the VPN device and the VPN Client as well.
- **Phase 1/ Phase 2 DH Group:** This option allows users to select Diffie-Hellman groups: Group 1/ Group 2/ Group 5.
- **Phase 1/ Phase 2 Encryption:** This option allows users to set this VPN tunnel to use any encryption mode. Note that this parameter must be identical to that of the remote encryption parameter: DES (64-bit encryption mode), 3DES (128-bit encryption mode), AES (the standard of using security code to encrypt information). It supports 128-bit, 192-bit, and 256-bit encryption keys.
- **Phase 1/Phase 2 Authentication:** This authentication option allows users to set this VPN tunnel to use any authentication mode. Note that this parameter must be

identical to that of the remote authentication mode: "MD5" or "SHA1".

- **Phase 1 SA Life Time:** The life time for this exchange code is set to 28800 seconds (or 8hours) by default. This allows the automatic generation of other exchange password within the valid time of the VPN connection so as to guarantee security.
- **Phase2 SA Life Time:** The life time for this exchange code is set to 3600 seconds (or 1hours) by default. This allows the automatic generation of other exchange password within the valid time of the VPN connection so as to guarantee security.
- **Preshared Key :** For the Auto (IKE) option, enter a password of any digit or characters in the text of "Pre-shared Key" (the example here is set as test), and the system will automatically translate what users entered as exchange password and authentication mechanism during the VPN tunnel connection. This exchange password can be made up of up to 30 characters.

Manual Mode

IPSec Setup

Key Exchange:	Manual
Incoming SPI:	
Outgoing SPI:	
Encryption:	DES
Authentication:	MD5
Encryption Key:	
Authentication Key:	

If the Manual mode is selected, users need to set encryption key manually without negotiation.

- It is divided into two types: "Encryption KEY" and "Authentication KEY". Users may enter an exchange password made up of either digits or characters. The systems will automatically translate what users entered into the exchange password and authentication mechanism during the VPN tunnel connection. This exchange password can be made up of digits and characters up to 23.
- Moreover, the exchange strings for "Incoming SPI" and "Outgoing SPI" must be identical to those of the connected VPN device. For the Incoming SPI parameters,

users must set it the same with the Outgoing SPI string of the remote VPN device. And the Outgoing SPI string must be the same with the incoming SPI string of the remote VPN device.

Advanced Setting- for IKE Protocol Only

Advanced

- Aggressive Mode
- Compress (Support IP Payload Compression Protocol(IPComp))
- Keep-Alive
- AH Hash Algorithm MD5
- Allow NetBIOS Broadcast Pass Through
- NAT Traversal
- Dead Peer Detection(DPD) Interval 10 seconds
- Allow specific boardcast packet Pass through Service Port Management

The advanced settings include Main Mode and Aggressive mode. For the Main mode, the default setting is set to VPN operation mode. The connection is the same to most of the VPN devices.

- Aggressive Mode: This mode is mostly adopted by remote devices. The IP connection is designed to enhance the security control if dynamic IP is used for connection.
- Use IP Header Compression Protocol: If this option is selected, in the connected VPN tunnel, the device supports IP Payload Compression Protocol.
- Keep Alive: If this option is selected, VPN tunnel will keep this VPN connection. This is mostly used to connect the remote node of the branch office and headquarter or used for the remote dynamic IP address.
- AH hash calculation: For AH (Authentication Header), users may select MD5/DSHA-1.
- NetBIOS Broadcast: If this option is selected, the connected VPN tunnel allows the passage of NetBIOS broadcast packet. This facilitates the easy connection with other Microsoft network; however, the traffic using this VPN tunnel will increase.

Dead Peer Detection (DPD): If this option is selected, the connected VPN tunnel will regularly transmit HELLO/ACK message packet to detect whether there is connection between the two ends of the VPN tunnel. If one end is disconnected, the device will disconnect the tunnel automatically and then create new connection. Users can define the transmission time for each DPD message packet, and the default value is 10 seconds.

10.1.2.2. Client to Gateway Setting

The following describes how an administrator builds a VPN tunnel between devices. Users can set this VPN tunnel to be used by one client or by a group of clients (Group VPN) at the client end. If it is used by a group of clients, the individual setting for remote clients can be reduced. Only one tunnel will be set and used by a group of clients, which allows easy setting.

(1) Situation in Tunnel :

Tunnel VPN Group

Tunnel No. :	<input type="text" value="1"/>
Tunnel Name :	<input type="text"/>
Interface :	<input type="text" value="WAN 1"/>
Enabled :	<input checked="" type="checkbox"/>

Tunnel No. :	Set the embedded VPN feature, please select the Tunnel number.
Tunnel Name :	<p>Displays the current VPN tunnel connection name, such as XXX Office. Users are well-advised to give them different names to avoid confusion.</p> <p>Note: If this tunnel is to be connected to the other VPN device, some device requires that the tunnel name is identical to the name of the host end to facilitate verification. This tunnel can thus be successfully enabled.</p>
Interface :	Users may select which port to be the node for this VPN channel. They can be applied for VPN connections.
Enabled :	Click to Enable to activate the VPN tunnel. This option is set to Enable by default. After users set up, users may select to activate this tunnel feature.

Local Group Setup

This local gateway authentication type (Local Security Gateway Type) must be identical with that of the remote type (Remote Security Gateway Type).

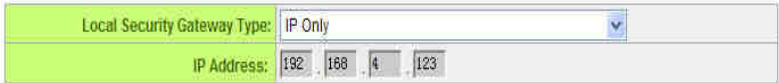
<p>Local Security Gateway Type :</p>	<p>This local gateway authentication type comes with five operation modes, which are: IP only - Authentication by the use of IP only IP + Domain Name (FQDN) Authentication, -IP + Domain name IP + E-mail Addr. (USER FQDN) Authentication, -IP + Email address Dynamic IP + Domain Name (FQDN) Authentication, -Dynamic IP address + Domain name Dynamic IP + E-mail Addr. (USER FQDN) Authentication. Dynamic IP address + Email address name</p> <p>(1) IP only:</p> <p>If users decide to use IP only, entering the IP address is the only way to gain access to this tunnel. The WAN IP address will be automatically filled into this space. Users don't need to do further settings.</p> <div data-bbox="571 1361 1353 1442" data-label="Form">  </div> <p>(2) IP + Domain Name(FQDN) Authentication:</p> <p>If users select IP + domain name type, please enter the domain name and IP address. The WAN IP address will be automatically filled into this space. Users don't need to do further settings. FQDN refers to the combination of host name and domain name and can be retrieved from the Internet, i.e. vpn.server.com. This IP address and domain name must be identical to those of the VPN secure gateway setting type to establish successful connection.</p>
--------------------------------------	--

Local Security Gateway Type:	IP + Domain Name(FQDN) Authentication
IP Address:	192 . 168 . 4 . 123
Domain Name:	

(3) IP + E-mail Addr. (USER FQDN) Authentication.

If users select IP address and E-mail, enter the IP address and E-mail address to gain access to this tunnel and the WAN IP address will be automatically filled into this space. Users don't need to do further settings.

Local Security Gateway Type:	IP + E-mail(User FQDN) Authentication
IP Address:	192 . 168 . 4 . 123
E-mail:	@

(4) Dynamic IP + Domain Name(FQDN) Authentication:

If users use dynamic IP address to connect to the device, users may select this option to link to VPN. If the remote VPN gateway requires connection to the device for VPN connection, this device will start authentication and respond to this VPN tunnel connection; if users select this option to link to VPN, please enter the domain name.

Local Security Gateway Type:	Dynamic IP + Domain Name(FQDN) Authentication
Domain Name:	

(5) Dynamic IP + E-mail Addr. (USER FQDN) Authentication.

If users use dynamic IP address to connect to the device, users may select this option to connect to VPN without entering IP address. When VPN Gateway requires for VPN connection, the device will start authentication and respond to VPN tunnel connection; if users select this option to link to VPN, enter E-Mail address to the empty field for E-Mail authentication.

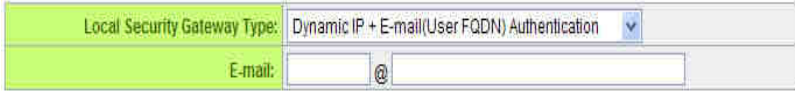
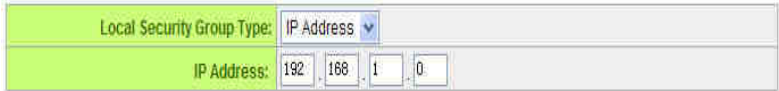
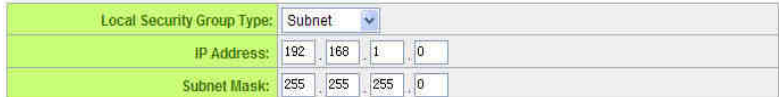
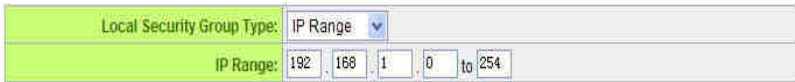
	 <p>Local Security Gateway Type: Dynamic IP + E-mail(User FQDN) Authentication E-mail: []@ []</p>
<p>Local Security Group Type :</p>	<p>This option allows users to set the local VPN connection access type. The following offers a few items for local settings. Please select and set appropriate parameters:</p> <p>4. IP address</p> <p>This option allows the only IP address which is entered to build the VPN tunnel.</p>  <p>Local Security Group Type: IP Address IP Address: 192 . 168 . 1 . 0</p> <p>Reference: When this VPN tunnel is connected, computers with the IP address of 192.168.1.0 can establish connection.</p> <p>5. Subnet</p> <p>This option allows local computers in this subnet to be connected to the VPN tunnel.</p>  <p>Local Security Group Type: Subnet IP Address: 192 . 168 . 1 . 0 Subnet Mask: 255 . 255 . 255 . 0</p> <p>Reference: When this VPN tunnel is connected, only computers with the session of 192.168.1.0 and with subnet mask as 255.255.255.0 can connect with remote VPN.</p> <p>6. IP Range</p> <p>This option allows connection only when IP address range which is entered after the VPN tunnel is connected.</p>  <p>Local Security Group Type: IP Range IP Range: 192 . 168 . 1 . 0 to 254</p> <p>Reference: When this VPN tunnel is connected, computers with the IP address of 192.168.1.0 ~254 can establish connection.</p>

Remote Group Setup :

Remote Group Setup

Remote Security Gateway Type:	IP Only
IP Address	<input type="text"/> - <input type="text"/> - <input type="text"/> - <input type="text"/>
Remote Security Group Type:	Subnet
IP Address:	<input type="text"/> - <input type="text"/> - <input type="text"/> - <input type="text"/>
Subnet Mask:	255 . 255 . 255 . 0

This remote gateway authentication type (Remote Security Gateway Type) must be identical to the remotely-connected local security gateway authentication type (Local Security Gateway Type).

<p>Remote Security Gateway Type :</p>	<p>This local gateway authentication type comes with five operation modes, which are:</p> <p>IP only IP + Domain Name (FQDN) Authentication IP + E-mail Addr. (USER FQDN) Authentication Dynamic IP + Domain Name (FQDN) Authentication Dynamic IP + E-mail Addr. (USER FQDN) Authentication</p> <p>(1) IP only:</p> <p>If users decide to use IP only, entering the IP address is the only way to gain access to this tunnel. The WAN IP address will be automatically filled into this space. Users don't need to do further settings.</p> <div style="border: 1px solid gray; padding: 5px; margin: 10px 0;"> <table border="1"> <tr> <td>Local Security Gateway Type:</td> <td>IP Only</td> </tr> <tr> <td>IP Address:</td> <td>192 . 168 . 4 . 123</td> </tr> </table> </div> <p>(2) IP + Domain Name(FQDN) Authentication:</p>	Local Security Gateway Type:	IP Only	IP Address:	192 . 168 . 4 . 123
Local Security Gateway Type:	IP Only				
IP Address:	192 . 168 . 4 . 123				

If users select IP + domain name type, please enter the domain name and IP address. The WAN IP address will be automatically filled into this space. Users don't need to do further settings. FQDN refers to the combination of host name and domain name and can be retrieved from the Internet, i.e. vpn.server.com. This IP address and domain name must be identical to those of the VPN secure gateway setting type to establish successful connection.

Local Security Gateway Type:	IP + Domain Name(FQDN) Authentication
IP Address:	192 . 168 . 4 . 123
Domain Name:	

(3) IP + E-mail Addr. (USER FQDN) Authentication.

If users select IP address and E-mail, enter the IP address and E-mail address to gain access to this tunnel and the WAN IP address will be automatically filled into this space. Users don't need to do further settings.

Local Security Gateway Type:	IP + E-mail(User FQDN) Authentication
IP Address:	192 . 168 . 4 . 123
E-mail:	@

(4) Dynamic IP + Domain Name(FQDN) Authentication:

If users use dynamic IP address to connect to the device, users may select this option to link to VPN. If the remote VPN gateway requires connection to the device for VPN connection, this device will start authentication and respond to this VPN tunnel connection; if users select this option to link to VPN, please enter the domain name.

Local Security Gateway Type:	Dynamcl IP + Domain Name(FQDN) Authentication
Domain Name:	

(5) Dynamic IP + E-mail Addr. (USER FQDN) Authentication.

If users use dynamic IP address to connect to the device,

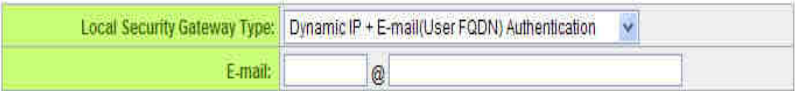
	<p>users may select this option to connect to VPN without entering IP address. When VPN Gateway requires for VPN connection, the device will start authentication and respond to VPN tunnel connection; if users select this option to link to VPN, enter E-Mail address to the empty field for E-Mail authentication.</p> 
--	---

IPSec Setup

IPSec Setup

Key Exchange:	Manual
Incoming SPI:	
Outgoing SPI:	
Encryption:	DES
Authentication:	MD5
Encryption Key:	
Authentication Key:	

If there is any encryption mechanism, the encryption mechanism of these two VPN tunnels must be identical in order to create connection. And the transmission data must be encrypted with IPSec key, which is known as the encryption "key". The device provides the following two encrypted Key Managements. They are Manual and IKE automatic encryption mode- IKE with Preshared Key (automatic). By using the drop down menu, select the desired encryption mode as illustrated below.

Encryption Management Protocol :

When users set this VPN tunnel to use any encryption and authentication mode, users must set the parameter of this exchange password with that of the remote. Setting methods include Auto (IKE) or Manual. To do the settings, select any one from the two options.

IPSec Setup

Key Exchange:	IKE with Preshared Key
Phase1 DH Group:	Group 1
Phase1 Encryption:	DES
Phase1 Authentication:	MD5
Phase1 SA Life Time:	28800 Seconds
Perfect Forward Secrecy	<input checked="" type="checkbox"/>
Phase2 DH Group:	Group 1
Phase2 Encryption:	DES
Phase2 Authentication:	MD5
Phase2 SA Life Time:	3600 Seconds
Preshared Key:	<input type="text"/>

Advanced +

IKE Protocol :

Click the shared key generated by IKE to encrypt and authenticate the remote user. If PFS (Perfect Forward Secrecy) is enabled, the Phase 2 shared key generated during the IKE coordination will conduct further encryption and authentication. When PFS is enabled, hackers using brute force to capture the key will not be able to get the Phase 2 key in such a short period of time.

- **Perfect Forward Secrecy:** When users check the PFS option, don't forget to activate the PFS function of the VPN device and the VPN Client as well.
- **Phase 1/ Phase 2 DH Group:** This option allows users to select Diffie-Hellman groups: Group 1/ Group 2/ Group 5.
- **Phase 1/ Phase 2 Encryption:** This option allows users to set this VPN tunnel to use any encryption mode. Note that this parameter must be identical to that of the remote encryption parameter: DES (64-bit encryption mode), 3DES (128-bit encryption mode), AES (the standard of using security code to encrypt information). It supports 128-bit, 192-bit, and 256-bit encryption keys.

- **Phase 1/Phase 2 Authentication:** This authentication option allows users to set this VPN tunnel to use any authentication mode. Note that this parameter must be identical to that of the remote authentication mode: "MD5" or "SHA1".
- **Phase 1 SA Life Time:** The life time for this exchange code is set to 28800 seconds (or 8hours) by default. This allows the automatic generation of other exchange password within the valid time of the VPN connection so as to guarantee security.
- **Phase2 SA Life Time:** The life time for this exchange code is set to 3600 seconds (or 1hours) by default. This allows the automatic generation of other exchange password within the valid time of the VPN connection so as to guarantee security.
- **Preshared Key :** For the Auto (IKE) option, enter a password of any digit or characters in the text of "Pre-shared Key" (the example here is set as test), and the system will automatically translate what users entered as exchange password and authentication mechanism during the VPN tunnel connection. This exchange password can be made up of up to 30 characters.

Manual Mode

IPSec Setup

Key Exchange:	Manual
Incoming SPI:	<input type="text"/>
Outgoing SPI:	<input type="text"/>
Encryption:	DES
Authentication:	MD5
Encryption Key:	<input type="text"/>
Authentication Key:	<input type="text"/>

If the Manual mode is selected, users need to set encryption key manually without negotiation.

- It is divided into two types: "Encryption KEY" and "Authentication KEY". Users may enter an exchange password made up of either digits or characters. The systems will automatically translate what users entered into the exchange password and authentication mechanism during the VPN tunnel connection. This exchange password can be made up of digits and characters up to 23.

- Moreover, the exchange strings for “Incoming SPI” and “Outgoing SPI” must be identical to those of the connected VPN device. For the Incoming SPI parameters, users must set it the same with the Outgoing SPI string of the remote VPN device. And the Outgoing SPI string must be the same with the incoming SPI string of the remote VPN device.

Advanced Setting- for IKE Preshared Key Only

Advanced

Aggressive Mode

Compress (Support IP Payload Compression Protocol(IPComp))

Keep-Alive

AH Hash Algorithm MD5

Allow NetBIOS Broadcast Pass Through

NAT Traversal

Dead Peer Detection(DPD) Interval 10 seconds

Allow specific boardcast packet Pass through

Service Port Management

Apply Cancel

The advanced settings include Main Mode and Aggressive mode. For the Main mode, the default setting is set to VPN operation mode. The connection is the same to most of the VPN devices.

- Aggressive Mode: This mode is mostly adopted by remote devices. The IP connection is designed to enhance the security control if dynamic IP is used for connection.
- Use IP Header Compression Protocol: If this option is selected, in the connected VPN tunnel, the device supports IP Payload Compression Protocol.
- Keep Alive: If this option is selected, VPN tunnel will keep this VPN connection. This is mostly used to connect the remote node of the branch office and headquarter or used for the remote dynamic IP address.
- AH hash calculation: For AH (Authentication Header), users may select MD5/DSHA-1.
- NetBIOS Broadcast: If this option is selected, the connected VPN tunnel allows the

passage of NetBIOS broadcast packet. This facilitates the easy connection with other Microsoft network; however, the traffic using this VPN tunnel will increase.

- Dead Peer Detection (DPD): If this option is selected, the connected VPN tunnel will regularly transmit HELLO/ACK message packet to detect whether there is connection between the two ends of the VPN tunnel. If one end is disconnected, the device will disconnect the tunnel automatically and then create new connection. Users can define the transmission time for each DPD message packet, and the default value is 10 seconds

Situation in Group VPN :

Tunnel VPN Group

Group No.	<input type="text" value="1"/>
Group Name:	<input type="text"/>
Interface:	<input type="button" value="WAN 1"/>
Enabled :	<input checked="" type="checkbox"/>

Group No. :	Two Group VPN settings at most.
Group Name :	Displays the current VPN tunnel connection name, such as XXX Office. Users are well-advised to give them different names to avoid confusion. Note: If this tunnel is to be connected to other VPN device, some device requires that the tunnel name is identical to the name of the host end to facilitate verification. This tunnel can thus be successfully enabled.
Interface :	From the pull-down list, users can select the Interface for this VPN tunnel.
Enabled :	Click to Enabled the VPN tunnel. This option is set to Enabled by default. After the set up, users may select to activate this tunnel feature.

Local Group Setup :

<p>Local Security Group Type :</p>	<p>This option allows users to set the local VPN connection access type. The following offers a few items for local settings. Please select and set appropriate parameters:</p> <p>(1) IP address</p> <p>This option allows the only IP address which is entered to build the VPN tunnel.</p> <div data-bbox="539 728 1321 817" style="border: 1px solid #ccc; padding: 5px;"> <p>Local Security Group Type: IP Address</p> <p>IP Address: 192 . 168 . 1 . 0</p> </div> <p>Reference: When this VPN tunnel is connected, computers with the IP address of 192.168.1.0 can establish connection.</p> <p>(2) Subnet</p> <p>This option allows local computers in this subnet can be connected to the VPN tunnel.</p> <div data-bbox="539 1160 1321 1258" style="border: 1px solid #ccc; padding: 5px;"> <p>Local Security Group Type: Subnet</p> <p>IP Address: 192 . 168 . 1 . 0</p> <p>Subnet Mask: 255 . 255 . 255 . 0</p> </div> <p>Reference: When this VPN tunnel is connected, only computers with the session of 192.168.1.0 and with subnet mask as 255.255.255.0 can connect with remote VPN.</p> <p>(3) IP Range</p> <p>This option allows connection only when IP address range which is entered after the VPN tunnel is connected.</p> <div data-bbox="539 1534 1337 1617" style="border: 1px solid #ccc; padding: 5px;"> <p>Local Security Group Type: IP Range</p> <p>IP Range: 192 . 168 . 1 . 0 to 254</p> </div> <p>Reference: When this VPN tunnel is connected, computers with the IP address of 192.168.1.0 ~254 can establish connection.</p>
------------------------------------	--

Remote Group Setup

▶ Remote Group Setup

Remote Security Client Type:	Domain Name(FQDN) ▼
Domain Name:	<input type="text"/>

<p>Remote Security client Type :</p>	<p>This setting offers three operation modes, which are:</p> <p>Domain Name (FQDN)</p> <p>E-mail Address (USER FQDN)</p> <p>Microsoft XP/2000 VPN Client</p> <p>(1) Domain Name(FQDN)</p> <p>If users select Domain Name type, please enter the domain name to be authenticated. FQDN refers to the combination of host name and domain name that are available on the Internet (i.e. vpn.Server.com).The domain name must be identical to the status setting of the client end to establish successful connection.</p> <table border="1"> <tr> <td style="background-color: #90EE90;">Remote Security Client Type:</td> <td>Domain Name(FQDN) ▼</td> </tr> <tr> <td style="background-color: #90EE90;">Domain Name:</td> <td><input type="text"/></td> </tr> </table> <p>(2) E-mail Addr. (USER FQDN)</p> <p>If users select this option, only filling in the E-mail address allows access to this tunnel.</p> <table border="1"> <tr> <td style="background-color: #90EE90;">Remote Security Client Type:</td> <td>E-mail(USER FQDN) ▼</td> </tr> <tr> <td style="background-color: #90EE90;">E-mail:</td> <td><input type="text"/> @ <input type="text"/></td> </tr> </table> <p>(3) Microsoft XP/2000 VPN Client</p> <p>If users select XP/2000 VPN Client end status, users don't need to do extra settings.</p>	Remote Security Client Type:	Domain Name(FQDN) ▼	Domain Name:	<input type="text"/>	Remote Security Client Type:	E-mail(USER FQDN) ▼	E-mail:	<input type="text"/> @ <input type="text"/>
Remote Security Client Type:	Domain Name(FQDN) ▼								
Domain Name:	<input type="text"/>								
Remote Security Client Type:	E-mail(USER FQDN) ▼								
E-mail:	<input type="text"/> @ <input type="text"/>								

	Remote Security Client Type: Microsoft XP/2000 VPN Client ▼
--	---

IPSec Setup

If there is any encryption mechanism, the encryption mechanism of these two VPN channel settings must be identical in order to establish connection. And the transmission data must be encrypted with IPSec key, which is also known as the encryption "key". The device provides the following two types of encryption management modes: Manual and IKE automatic encryption mode- IKE with Preshared Key (automatic). If the Group VPN is selected or the dynamic IP address of the Remote Security Gateway Type is applied, Aggressive Mode will be enabled automatically without the option of Manual mode.

Encryption Management Protocol :

IPSec Setup

Key Exchange:	IKE with Preshared Key
Phase1 DH Group:	Group 1 ▼
Phase1 Encryption:	DES ▼
Phase1 Authentication:	MD5 ▼
Phase1 SA Life Time:	28800 Seconds
Perfect Forward Secrecy	<input checked="" type="checkbox"/>
Phase2 DH Group:	Group 1 ▼
Phase2 Encryption:	DES ▼
Phase2 Authentication:	MD5 ▼
Phase2 SA Life Time:	3600 Seconds
Preshared Key:	<input type="text"/>

Advanced -

- **Perfect Forward Secrecy:** When users check the PFS option, make sure to activate the PFS feature of the VPN device and that VPN Client as well.
- **Phase 1/Phase 2 DH Group:** This option allows users to select Diffie-Hellman

groups: Group 1/ Group 2/ Group 5.

- **Phase1/Phase2 Encryption:** This option allows users to set this VPN channel to use any encryption mode. Note that this parameter must be identical to that of the remote encryption parameter: DES (64 - bit encryption mode), 3DES (128-bit encryption mode), AES (the standard of using security code to encrypt information). It supports 128-bit, 192-bit, and 256-bit encryption keys.
- **Phase 1/Phase 2 Authentication:** This authentication option allows users to set this VPN tunnel to use any authentication mode. Note that this parameter must be identical to that of the remote authentication mode: "MD5" or "SHA1".
- **Phase1 SA Life Time:** The life time for this exchange code is 28800 seconds (or 8 hours) by default. This allows the automatic generation of other exchange passwords within the valid time of the VPN connection so as to guarantee security.
- **Phase2 SA Life Time:** The life time for this exchange code is 3600 seconds (or 1 hour) by default. This allows the automatic generation of other exchange passwords within the valid time of the VPN connection so as to guarantee security.
- **Preshared Key:** For the Auto (IKE) option, enter a password of any digit or character in the text of "Pre-shared Key" (the example here is set as test), and the system will automatically translate what users entered as exchange password and authentication mechanism during the VPN tunnel connection. This exchange password can be made up of up to 30 characters.

Advanced Setting-for IKE Preshared Key Only

 **Advanced**

- Aggressive Mode
- Compress (Support IP Payload Compression Protocol(IPComp))
- Keep-Alive
- AH Hash Algorithm MD5
- Allow NetBIOS Broadcast Pass Through
- NAT Traversal
- Dead Peer Detection(DPD) Interval 10 seconds
- Allow specific broadcast packet Pass through Service Port Management

The advanced settings include Main Mode and Aggressive mode. In Main mode, the default setting is VPN operation mode. The connection is the same as most of the VPN device.

- **Aggressive Mode:** This mode is mostly adopted by remote devices. The IP connection is designed to enhance the security control if dynamic IP is used for connection.
- **Use IP Header Compression Protocol:** If this option is selected, in the connected VPN tunnel, the device supports IP Payload compression Protocol.
- **Keep Alive:** If this option is selected, VPN channel will keep this VPN connection. This is mostly used to connect the remote node of the branch office and headquarter or used for the remote dynamic IP address.
- **AH Hash Calculation:** For AH (Authentication Header), users may select MD5/DSHA-1.
- **NetBIOS Broadcast:** If this option is selected, the connected VPN tunnel allows the passage of NetBIOS broadcast packet. This facilitates the easy connection with other Microsoft Network Neighborhoods; however, the traffic using this VPN tunnel will increase.
- **Dead Peer Detection (DPD):** If this option is selected, the connected VPN tunnel will regularly transmit HELLO/ACK message packet to detect whether there is connection between the two ends of the VPN tunnel. If one end is disconnected, the device will disconnect the tunnel automatically and then create new connection. Users can define the transmission time for each DPD message packet, and the default value is 10 seconds

10.1.3. PPTP Setting

It supports the PPTP of Window XP/ 2000 to create point-to-point tunnel protocol for single- device users to create VPN connection.

VPN
Summary
Gateway to Gateway
Client to Gateway
▶ PPTP Setup
PPTP Status
VPN Pass Through

Enabled PPTP Server

▶ PPTP Client IP Range

Range Start : 192 . 168 . 1 . 150
Range End : 192 . 168 . 1 . 199

▶ Remote Client Setup

User Name :	<input type="text"/>
Password :	<input type="password"/>
Confirm Password :	<input type="password"/>
<input type="button" value="Add to list"/>	
<div style="border: 1px solid gray; height: 100px; width: 100%;"></div>	
<input type="button" value="Delete selected item"/>	

Enabled PPTP Server :

When this option is selected, the point-to-point tunnel protocol PPTP server can be enabled.

PPTP Client IP Range :	Please enter PPTP IP address range so as to provide the remote users with an entrance IP into the local network. Enter Range Start: Enter the value into the last field. Enter Range End: Enter the value into the last field.
Username :	Please enter the name of the remote user.
Password : Confirm Password :	Enter the password and confirm again by entering the new password.
Add to list :	Add a new account and password.
Delete selected item :	Delete Selected Item.

All PPTP Status : Displays all successfully connected users, including username, remote IP address, and PPTP address.

VPN
Summary
Gateway to Gateway
Client to Gateway
PPTP Setup
▶ PPTP Status
VPN Pass Through

▶ PPTP Client Table

User Name	Remote Client IP	Local IP
-----------	------------------	----------

Refresh

10.1.4. VPN Pass Through

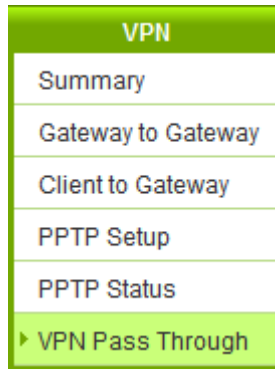

IPSec Pass Through :	<input checked="" type="radio"/> Enabled <input type="radio"/> Disabled
	<input checked="" type="radio"/> Fixed Source Port <input type="radio"/> Change Source Port
PPTP Pass Through :	<input checked="" type="radio"/> Enabled <input type="radio"/> Disabled
L2TP Pass Through :	<input checked="" type="radio"/> Enabled <input type="radio"/> Disabled



IPSec Pass Through :	If this option is enabled , the PC is allowed to use VPN-IPSec packet to pass in order to connect to external VPN device.
Fixed Source Port Change Source Port :	This option is only required when having VPN connection with Cisco VPN Server and Client. Because VPN Server does not accept two connections with the same IP and same source port, the second connection needs to change source port from UDP 500 to the other random port. If choosing Fixed Source Port, the second connection will still keep the connection with UDP 500.
PPTP Pass Through :	If this option is enabled , the PC is allowed to use VPN-PPTP packet to pass in order to connect with external VPN device.
L2TP Pass Through :	If this option is enabled , the PC end is allowed to use VPN- L2TP packet to pass in order to connect with external VPN device.

After modification, push **"Apply"** button to save the network setting or push **"Cancel"** to keep the settings unchanged.

10.2. QnoKey

Introduces how Qno VPN devices conducts preliminary configuration of the data from the user end and how to set the QnoKey user to successfully create QnoKey by using QnoKey management software.

10.2.1. QnoKey Summary

Login to the web-based UI and click on the QnoKey menu to display the page that summarizes the current status information of QnoKey, as illustrated below :

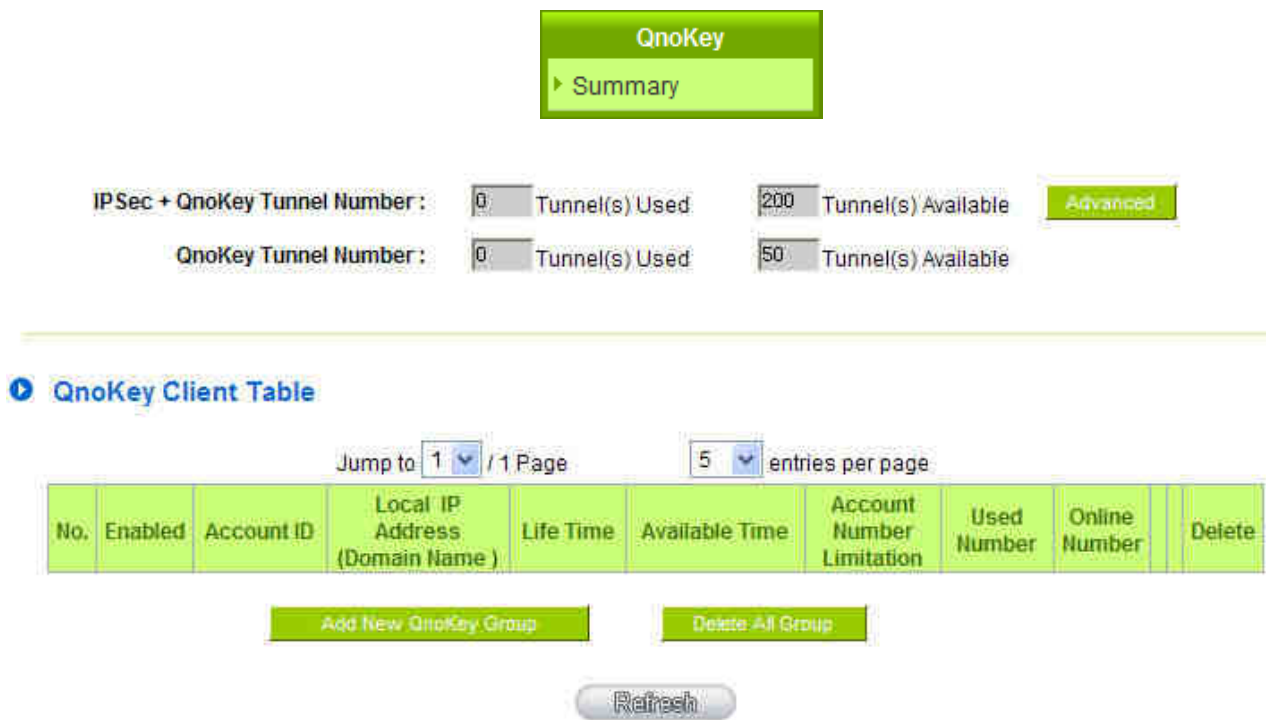

QnoKey
▶ Summary

IPSec + QnoKey Tunnel Number : 0 Tunnel(s) Used 200 Tunnel(s) Available **Advanced**

QnoKey Tunnel Number : 0 Tunnel(s) Used 50 Tunnel(s) Available

▶ **QnoKey Client Table**

Jump to 1 / 1 Page 5 entries per page

No.	Enabled	Account ID	Local IP Address (Domain Name)	Life Time	Available Time	Account Number Limitation	Used Number	Online Number	Delete
-----	---------	------------	--------------------------------	-----------	----------------	---------------------------	-------------	---------------	--------

Add New QnoKey Group **Delete All Group**

Refresh

QnoKey Tunnel Number :	Displays how many tunnels are applied and the total tunnel number of QnoKey tunnel. Through advanced setting, users can set the tunnel number of IPSec and QnoKey.
Enabled :	Displays whether QnoKey username is enabled.
Account ID :	Displays the user name group of QnoKey.
Local IP Address (Domain Name) :	Server IP address or the applied domain name.
Life Time :	The present valid time of QnoKey; permanent use is displayed as Forever.

Available Time :	If the number of days of using QnoKey is set, the remaining time is displayed here.
Account Number Limitation :	The upper limited number of QnoKey users.
Used Number :	The number of QnoKey in use.
Online Number :	Displays the number of connected devices that are using QnoKey.
Show Table :	Displays the list of all QnoKey users.
Delete :	Deletes one user name group setting rule.
Go to <input type="text" value="1"/> page :	Goes to the page where summarized information is needed.
<input type="text" value="5"/> Entries per page :	Each summary page displays several group messages.
Add Qnokey Group :	Add new group settings.
Delete All Group :	Delete all the group settings.

10.2.2 Qnokey Group Setup

Press Add New Qnokey Group to enter Group Setup page, as illustrated below.

Group Account Setup

Enable this rule

Group Account ID :	<input type="text"/>
Interface :	<input type="checkbox"/> WAN 1 <input type="text" value="0.0.0.0"/> (IP Address/ Domain Name) <input type="checkbox"/> WAN 2 <input type="text" value="192.168.4.193"/> (IP Address/ Domain Name) <input type="checkbox"/> WAN 3 <input type="text" value="0.0.0.0"/> (IP Address/ Domain Name) <input type="checkbox"/> WAN 4 <input type="text" value="0.0.0.0"/> (IP Address/ Domain Name)
Life Time :	<input checked="" type="radio"/> Forever <input type="radio"/> <input type="text"/> Day
Account Number Limitation :	<input type="text"/> (Max: 100)
Stolen Key Login Action :	<input type="text" value="Lock Key"/>

This page is designed for QnoKey group setup. Group parameters for QnoKey include WAN ports, valid time, and number of users, and protection actions for potential QnoKey losses. These setting options facilitate classified management for QnoKey users and enhance security.

Enable this rule :	Select this option to activate this setting rule.
Group Account ID :	Enter the QnoKey group name that users would like to set up.
Interface :	<p>Select WAN port and enter the correct IP address which corresponds to WAN port or the domain name (analyzed by DDNS).If WAN ports are empty, IP entry is not necessary so that VPN connection will not fail. This option allows users to select which WAN port to make connection, facilitating management. If WAN1 is selected, QnoKey group users can connect through only WAN1. If both WAN 1and WAN 2 are selected, QnoKey group users are allowed to make connection via WAN 1or WAN 2. When WAN1 is disconnected, WAN2 will be automatically connected to back up VPN connection.</p> <p>Note :</p> <ul style="list-style-type: none"> ■ If WAN port is selected and the network connection type is set as static IP, the system will automatically display this WAN IP. Administrator does not need to enter it manually. ■ If WAN port is selected and the network connection is set to other types such as DHCP/PPPoE, administrator needs to enter the IP address or domain name (through DDNS analysis).
Life Time :	Set the valid time for QnoKey group. If the QnoKey is

	for normal and frequent use, the option " Forever " may be selected so the user end valid time is infinite. If the user is more complicated or if it is meant for mobile users who travel on business, the VPN security can be guaranteed by setting the valid time of QnoKey as "1~99" days according to the desired number of days to be set.
Account Number Limitation :	Set the maximum number of QnoKey users (from "1~100") allowed by the group setting rules.
Stolen Key Login Action :	In the drop-down list, select operation options for the missing QnoKey. In the event of losing QnoKey, there are three options for selection: "Do Nothing", "Clear Key," and "Lock Key". Setting this feature on QnoKey can enhance VPN security. Select "Do Nothing" to do no change after the Key is lost. Select "Clear Key" to clean up the QnoKey settings when the VPN connection is established again after the QnoKey is lost. Select "Block Key" to block the VPN connection after the QnoKey is lost.

Press "**Apply**" to confirm the group settings and press "**Cancel**" to cancel the setting. Press "**Back**" to return the previous page.

Pressing "**Apply**" to display a dialog box in which it will ask if users want to continue to add new setting group. Click "**Ok**" to add another group setting or "**Cancel**" to return to the QnoKey Summary page. It is illustrated as below.



On the QnoKey Summary page, the defined group will be displayed, which is illustrated as below.

QnoKey Client Table

Jump to / 1 Page entries per page

No.	Enabled	Account ID	Local IP Address (Domain Name)	Life Time	Available Time	Account Number Limitation	Used Number	Online Number			Delete
1	<input checked="" type="checkbox"/>	test	192.163.3.33	Forever		30	0	0	Show List	Edit	

When a new rule is created, "Show List" and "Edit" button will be displayed behind the rule. Click on "Show List" to show the list of users applying this group rule. Click "Edit" to change settings. Click the trash can icon to delete this setting.

10.2.3 Qnokey Account List

Click "Show List" to show the Account List page applying this rule.

Group Account list

Group Account ID :

No.	Enabled	QnoKey SN	User Name	Status	Stolen Key Login Action	Bind MAC	MAC Address	Remote Client IP	Local IP	Delete
-----	---------	-----------	-----------	--------	-------------------------	----------	-------------	------------------	----------	--------

Group Account ID :	Displays the group ID to which the user belongs to.
Enabled :	Click this option to activate QnoKey user.
QnoKey SN :	Displays the QnoKey serial number.
User Name :	Displays the QnoKey user name.
Status :	Displays the QnoKey connection status. "Connect" means

	the user is connected and online; "Disconnect" means no connection and offline.
Stolen Key Login Action :	Select this option to create settings if the QnoKey is lost.
Bind MAC :	If there is hardware binding, QnoKey can only execute on the bound PC.
MAC Address :	If hardware binding function is enabled, it will show the MAC address which Qnokey is bound with, not the PC MAC address.
Delete :	Delete the user Qnokey connection information.

10.3. QVM VPN Function Setup

The QVM-series device provides three major convenient functions:

1. **Smart Link IPSec VPN:** Easy VPN setup replaces the conventional complicated VPN setup process by entering **Server IP, User Name,** and **Password.**
2. **Central Control Feature:** Displays a clear VPN connection status of all remote ends and branches. Its central control screen allows setup from remote into external client ends.
3. **VPN Disconnection Backup:** Solves data transmission problem arising from failed ISP connection with remote ends or the branches.

10.3.1. QVM Server Settings

Select QVM Feature as Server mode :

QVM VPN	
▶	Setup
	Status

▶ Setup Mode

QVM Server ▼

▶ QVM Server Setup

Account ID :	<input type="text"/>
Password :	<input type="password"/>
Confirm Password :	<input type="password"/>
IP Address :	<input type="text" value="192"/> <input type="text" value="168"/> <input type="text" value="1"/> <input type="text" value="0"/>
Subnet Mask :	<input type="text" value="255"/> <input type="text" value="255"/> <input type="text" value="255"/> <input type="text" value="0"/>
VPN HUB Function :	<input type="checkbox"/>
Enabled :	<input type="checkbox"/>
<input type="button" value="Add to list"/>	
<div style="border: 1px solid gray; height: 100px; width: 100%;"></div>	
<input type="button" value="Delete selected item"/>	
<input type="button" value="Apply"/> <input type="button" value="Cancel"/>	

Account ID :	Must be identical to that of the remote client end. Please enter the remote client user name in either English or Chinese.
Password :	Must be identical to that of the remote client end.
Confirm Password :	Please enter the password and confirm again.
IP Address : Subnet Mask :	Refers to the specific network IP address and subnet mask, which has to build connection with the remote client end.
VPN Hub Function :	After branch and headquarter are connected, branches can access each other easily without having other tunnels.
Enabled :	Enable this account.
Add to list :	Add a new account and password.
Delete selected item :	Delete the selected user.

After modification, push "Apply" button to save the network setting or push "Cancel" to keep the settings unchanged.

10.3.2. QVM Status

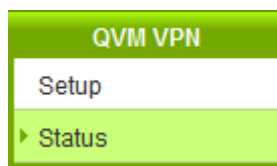

QVM Client Table

No.	Account ID	Status	Interface	Start Time	End Time	Duration	Control	Config.
1	test			---	---	---	Enabled	Edit

Refresh

Account :	Displays the remote client user. Green means connection, blue waiting for connection and red for QVM disconnection.
Status :	Displays the QVM VPN connection status. Red means disconnection and green means connection.
Interface :	Shows which WAN port is applied to connect to this remote QVM.
Start Time :	Shows the starting time of QVM.
End Time :	Shows the ending time of QVM.
Duration :	Shows the total time used from the Start to the End of this QVM.
Control :	Shows the status of this QVM: waiting for connection (Waiting), stop the connection (Disconnect), and Disable this feature/ Enable this QVM to enter the status of waiting for connection.
Config. :	Click Edit to enter the setting items to be changed.

10.3.3. QVM Client Settings

Select QVM feature as Client mode :

Setup Mode

QVM Client

QVM Client Setup

Account ID :

Password :

Confirm Password :

QVM VPN :

(IP Address or Dynamic Domain Name)

Status :

Keep Alive: Redial Period Min.

QVM Backup Tunnel

Advanced Function

Change QVM Client's Service Port :

Account ID :	Must be identical to that of the server account ID.
Password :	Must be identical to that of the server password.
Confirm Password :	Please enter the password and confirm again.
QVM VPN (IP Address or Dynamic Domain Name) :	Input QVM VPN Server IP address or domain name.
Status :	Displays QVN connection status.
Keep Alive: Redial Period	This function is to set re- connect duration if QVM contention drops. The range is 1~60 mins.

<input type="text" value="5"/> Mins :	
QVM Backup Tunnel :	You can input at most 3 backup IP addresses or domain names for backup. Once the connection is dropped, the function will be automatically enabled to backup the VPN connection and ensure data transition security.
Advanced Function : Change QVM Client's Service Port :	In some environment, port 443 has been used, for example, E-Mail Forwarding. To avoid the conflict with QVM, QVM port can be changed to other encryption ports, such as 10443.

After modification, press **"Apply"** to save the network setting or press **"Cancel"** to keep the settings unchanged.

XI. Virtue Route

Virtual Router enable the branch only has single ISP service can enjoy two different broadband network. The branch can access another ISP network with connecting to headquarter server with dual-bradband connection. As the result, the linking problem between different ISP network will be sloved.

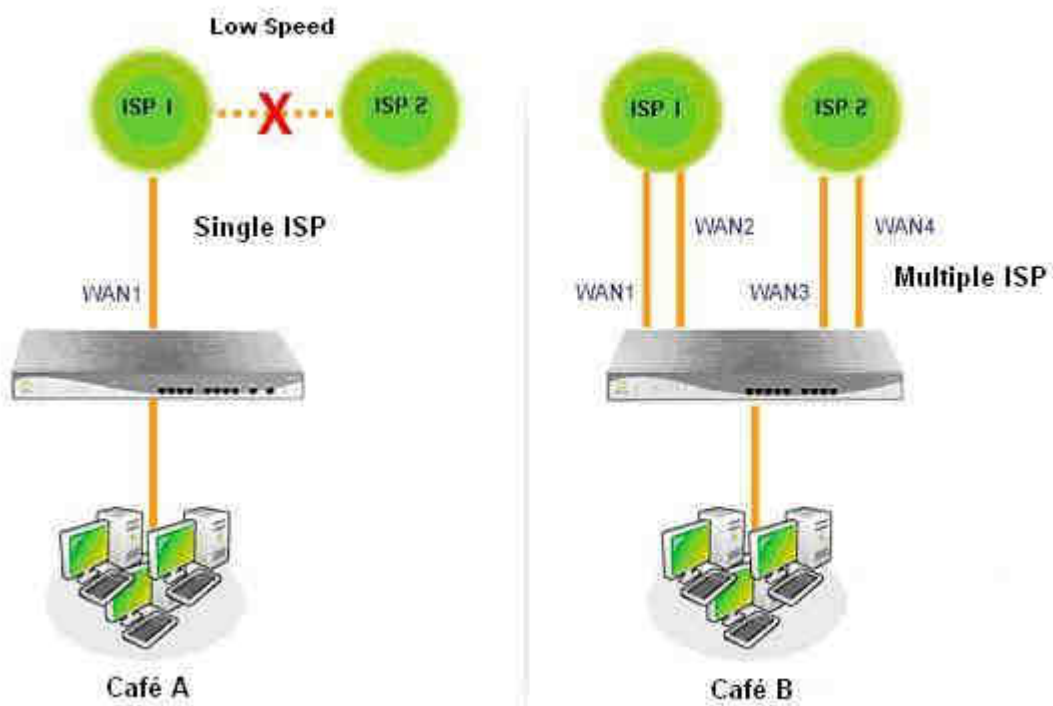

As the figure showed above, Café A has only one ISP service. Because of narrow bandwidth between two different ISP, the connection speed that users access to the web or on-line game on another network will be very slow. On the other hands, Café B owns two different ISP service. No matter what network users access to, the connection speed will be fast.

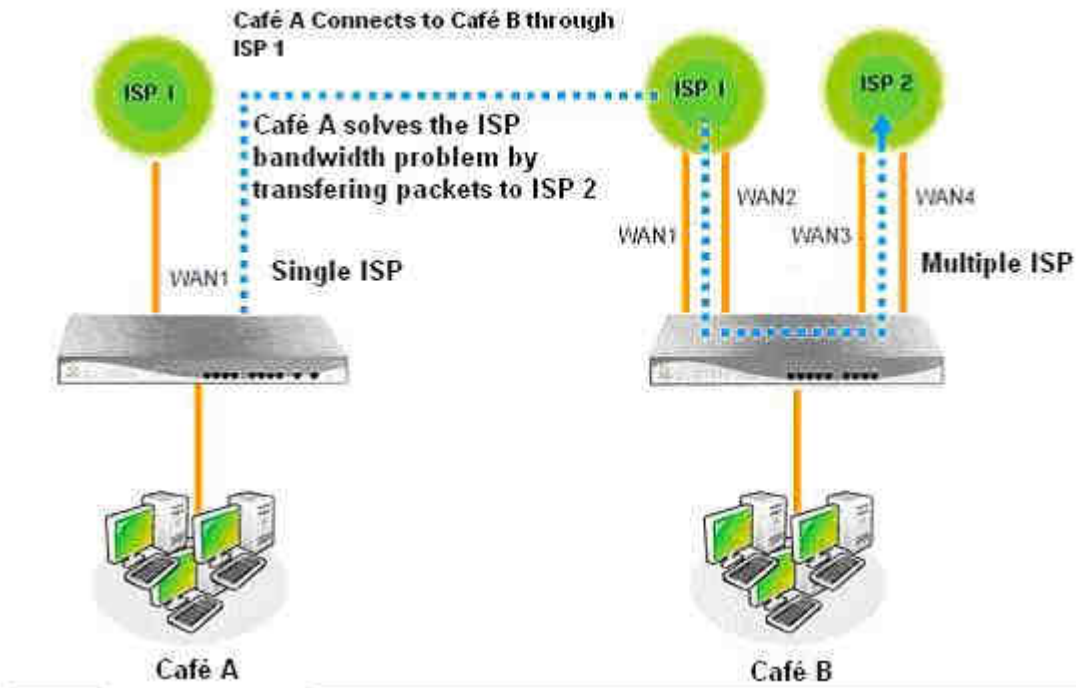

Café A can enable virtual route function and link to Café B's device. They can access another ISP service through Café B's network. It seems that Café A employ dual ISP service, too. If users in Café A want to access to another ISP network, the link speed won't be restricted.

11.1 Virtue Route Server (PPTP Server)

The Chapter introduces how to configure a Virtue Route server. Virtue Route builds PPTP on the basis of PPP (Point-to-point Protocol), it strengthens the security of PPP. Virtue Route enables encryption transmission between PPTP server and client, and enables PPTP server to verify the remote clients. Go to "PPTP Setup" and click "Enabled PPTP Server."



Enabled PPTP Server

PPTP Client IP Range

Range Start : 192 . 168 .	<input type="text" value="1"/>	.	<input type="text" value="150"/>
Range End : 192 . 168 .	<input type="text" value="1"/>	.	<input type="text" value="199"/>

Remote Client Setup

User Name:

Password:

Confirm Password:

Enabled PPTP Server :	When this option is selected, the point-to-point tunnel protocol PPTP server can be enabled.
PPTP Client IP Range :	Please enter PPTP IP address range so as to provide the remote users with an entrance IP into the local network. Enter Range Start: Enter the value into the last field. Enter Range End: Enter the value into the last field.
Username :	Please enter the name of the remote user.
Password : Confirm Password :	Enter the password and confirm again by entering the new password.

Add to list :	Add a new account and password.
Delete selected item :	Delete Selected Item.

All PPTP Status : Displays all successfully connected users, including username, remote IP address, and PPTP address.

PPTP Client Table

User Name	Remote Client IP	Local IP
-----------	------------------	----------

Refresh

11.2 Virtue Route Client



Virtual Route

Enabled

Binding Interface :	WAN1	
Binding Network :	Netcome	Import IP Range
Binding Service Port :	All	Import Port Range
When connection failed, Retry every 30 minutes		
Remote Host IP Address :	0 . 0 . 0 . 0	
User Name :		
Password :		
Status :		

Apply Cancel

Enabled	To activate the function.
Binding Interface	To select which WAN port is binded: WAN1~WAN4
Binding Network	To select the binding network: Netcome or Self-Defined.
Import IP Range	Click "Browse" to import binding IP range.
Binding Service Port	To select the port that will execute virtual route: All port, Game, or Self-defined.
Import Port Range	Click "Browse" to import binding port range.
When connection failed, Retry every 30 minutes	Input the retry period when connection failed. The default value is 30 minutes.

Remote Host IP Address	Input the IP of virtual route server.
User Name	Input the user name.
Password	Input the password.
Status	Show the link status: Connect or Disconnect.

Self-Defined IP

To build a self-defined IP users can use a text-based editor, such as Notepad, which is included with Windows system. Follow the text format in the figure below to key in the destination IPs users want to assign. For example, if the destination IP address range users want to designate is 140.115.1.1 ~ 140.115.1.255, key in 140.115.1.1 ~ 140.115.1.255 in Notepad. The next destination IP address range should be keyed in the next line. Attention! Even if only one destination IP address is to be assigned, it should follow the same format. For example, if the destination IP address is 210.66.161.54, it should be keyed in as 210.66.161.54~210.66.161.54. After the document has been saved (the extension file name is .txt), users can import the IP range of self-defined strategy.



Self-Defined Port

To build a self-defined Port users can use a text-based editor, such as Notepad, which is included with Windows system. For example, if the destination port users want to designate is TCP/3724~3724, key in TCP/3724~3724 in Notepad. The next destination port should be keyed in the next line. After the document has been saved (the extension file name is .txt), users can import the port of self-defined strategy.

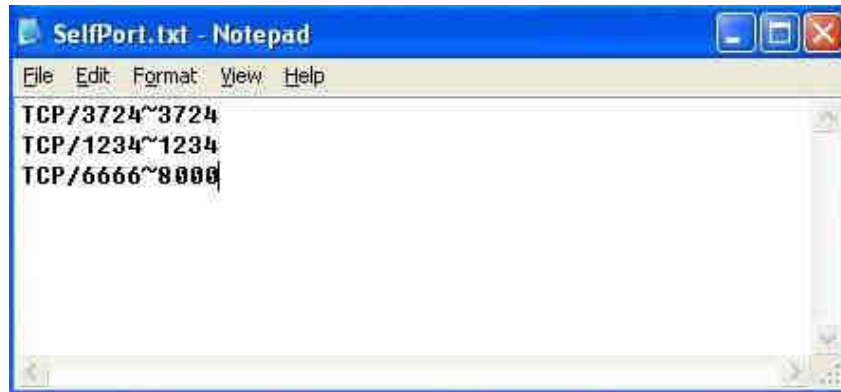

XII. Advanced Function

12.1 DMZ Host/ Port Range Forwarding

DMZ Host

DMZ Private IP Address (DMZ Host): 192 . 168 . 1 . 100

Port Range Forwarding

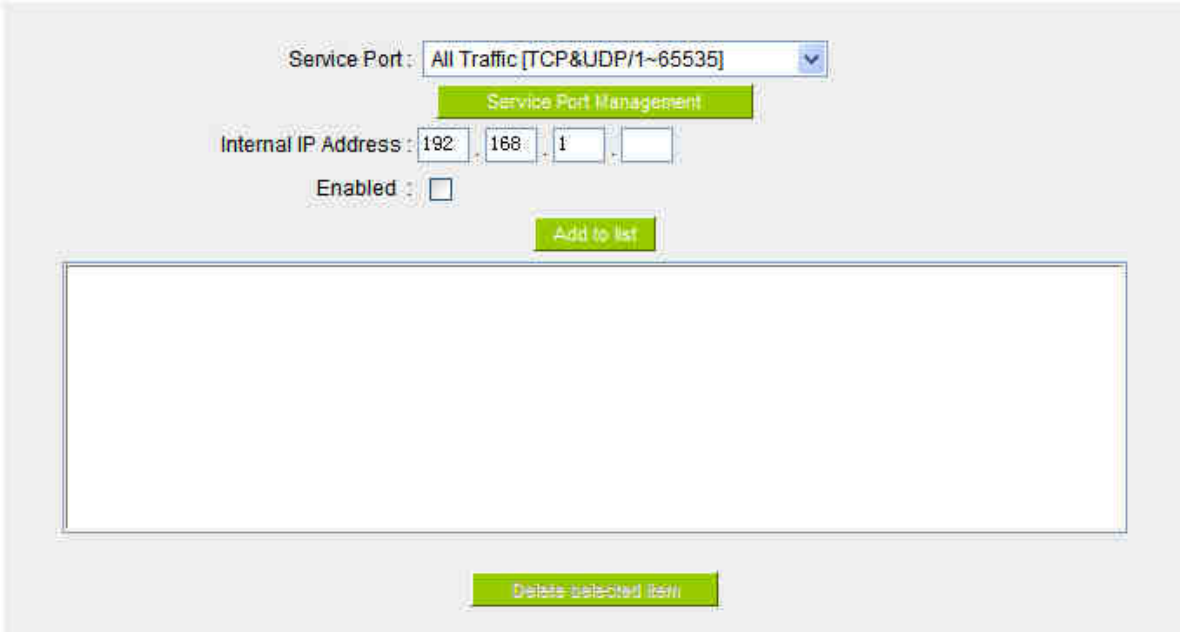

Service Port: All Traffic [TCP&UDP/1~65535]

Service Port Management

Internal IP Address: 192 . 168 . 1 .

Enabled:

Add to list

--

Delete selected item

12.1.1 DMZ Host

When the NAT mode is activated, sometimes users may need to use applications that do not support virtual IP addresses such as network games. We recommend that users map the device actual WAN IP addresses directly to the Intranet virtual IP addresses, as follows:

If the "DMZ Host" function is selected, to cancel this function, users must input "0" in the following "DMZ Private IP". This function will then be closed.

After the changes are completed, click "Apply" to save the network configuration modification, or click "Cancel" to leave without making any changes.

12.1.2 Port Range Forwarding

Setting up a Port Forwarding Virtual Host: If the server function (which means the server for an external service such as WWW, FTP, Mail, etc) is contained in the network, we recommend that users use the firewall function to set up the host as a virtual host, and then convert the actual IP addresses (the Internet IP addresses) with Port 80 (the service port of WWW is Port 80) to access the internal server directly. In the configuration page, if a web server address such as 192.168.1.50 and the Port 80 has been set up in the configuration, this web page will be accessible from the Internet by keying in the device actual IP address such as, <http://211.243.220.43>.

At this moment, the device actual IP will be converted into "192.168.1.50" by Port 80 to access the web page.

In the same way, to set up other services, please input the server TCP or UDP port number and the virtual host IP addresses.

Port Range Forwarding

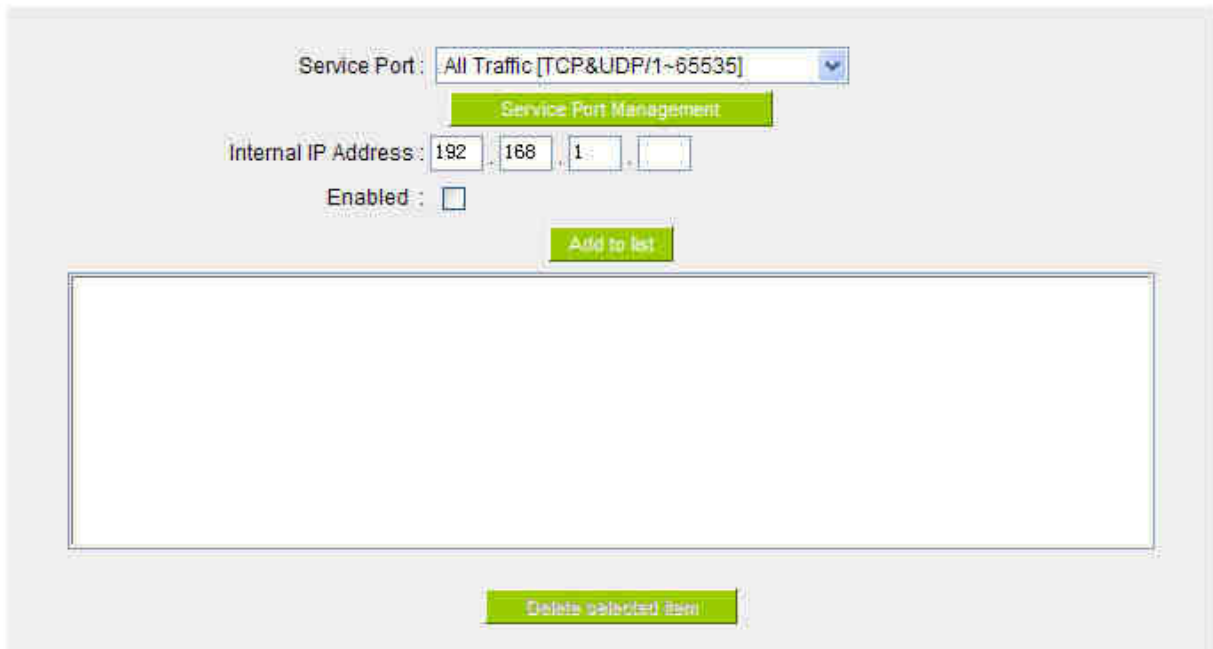

Service :	To select from this option the default list of service ports of the virtual host that users want to activate. Such as: All (TCP&UDP) 0~65535, 80 (80~80) for WWW, and 21~21 for FTP. Please refer to the list of default service ports.
-----------	--

IP Address :	Input the virtual host IP address.
Enabled :	Activate this function.
Service Port Management :	Add or remove service ports from the list of service ports.
Add to list :	Add to the active service content.

Service Port Management

The services in the list mentioned above are frequently used services. If the service users want to activate is not in the list, we recommend that users use "Service Port Management" to add or remove ports, as follows :

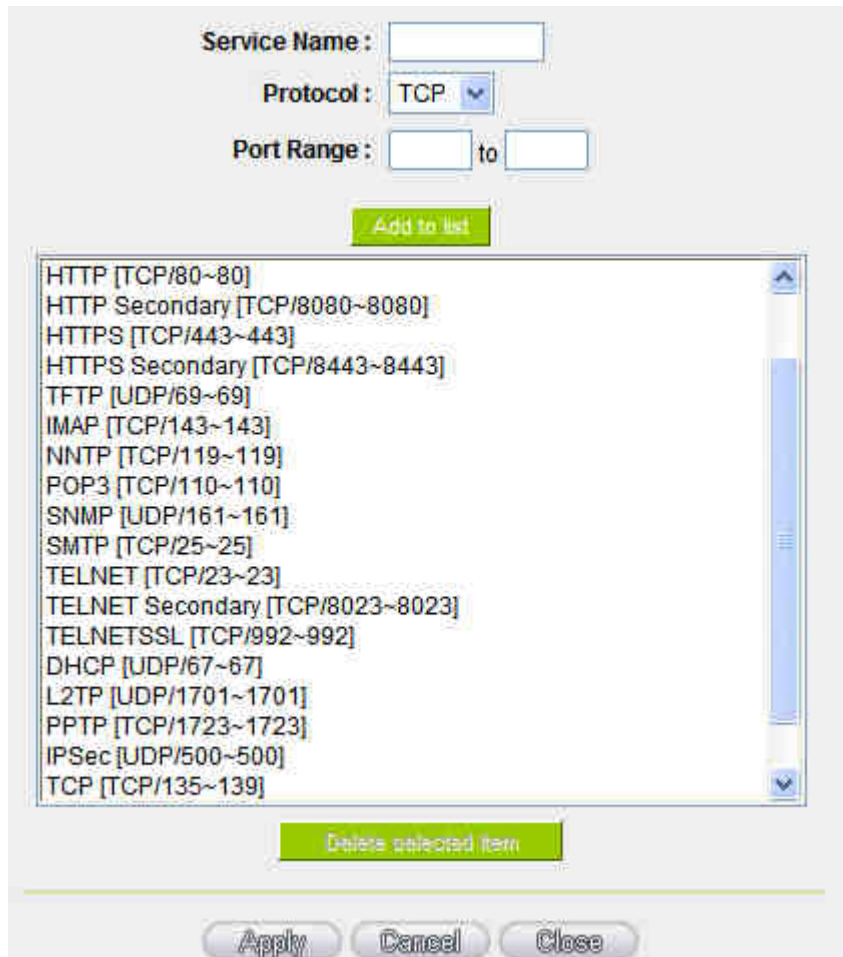

Service Name :

Protocol : TCP

Port Range : to

- HTTP [TCP/80~80]
- HTTP Secondary [TCP/8080~8080]
- HTTPS [TCP/443~443]
- HTTPS Secondary [TCP/8443~8443]
- FTP [UDP/69~69]
- IMAP [TCP/143~143]
- NNTP [TCP/119~119]
- POP3 [TCP/110~110]
- SNMP [UDP/161~161]
- SMTP [TCP/25~25]
- TELNET [TCP/23~23]
- TELNET Secondary [TCP/8023~8023]
- TELNETSSL [TCP/992~992]
- DHCP [UDP/67~67]
- L2TP [UDP/1701~1701]
- PPTP [TCP/1723~1723]
- IPSec [UDP/500~500]
- TCP [TCP/135~139]

Service Name :	Input the name of the service port users want to activate on the list, such as E-donkey, etc.
----------------	---

Protocol :	To select whether a service port is TCP or UDP.
Port Range :	To activate this function, input the range of the service port locations users want to activate such as 500~500 or 2300~2310, etc.
Add to list :	Add the service to the service list. It supports up to 100 rules.
Delete selected item :	To remove the selected services.
Apply :	Click the "Apply" button to save the modification.
Cancel :	Click the "Cancel" button to cancel the modification. This only works before "Apply" is clicked.
Close :	Quit this configuration window.

12.1.3 Port Triggering

For some special application software, the Internet accessing port numbers are unsymmetrical. Therefore, the port numbers for this special software must be input in the "Port Triggering" :

Port Triggering

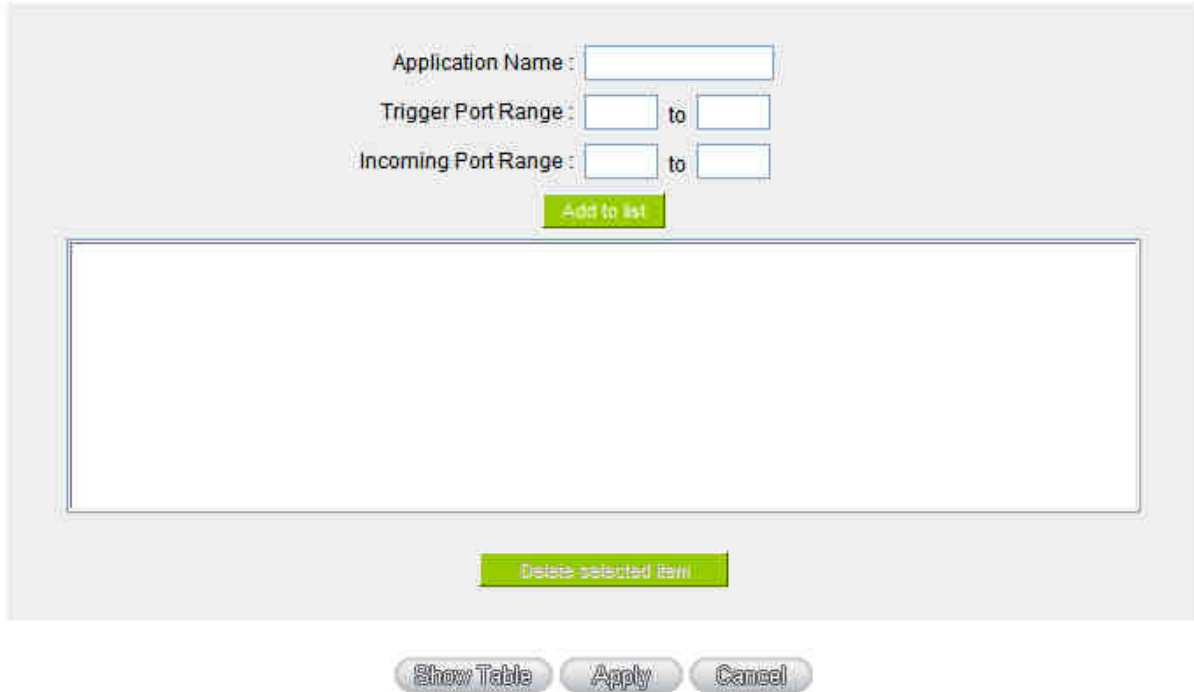

Application Name :	Users can define names for special application software. This is to make management simple.
Trigger Port Range :	Input the port numbers for data going from the device to the Internet. (Such as 9000~6600).
Incoming Port Range :	Input the port numbers for data coming in from the Internet to the device. (Such as 2004~2005).
Add to list :	Add the service to the active service list.
Delete selected item :	Remove selected services.
Show Table :	Click to show all the setting in the list.
Apply :	Click the "Apply" button to save the modification.
Cancel :	Click the "Cancel" button to cancel the modification. This only works before "Apply" is clicked.

12.2 UPnP

UPnP (Universal Plug and Play) is a protocol set by Microsoft. If the virtual host supports UPnP system (such as Windows XP), users could also activate the PC UPnP function to work with the device.

UPnP Function (Automatically Mapping) : Yes NO

UPnP Mapping

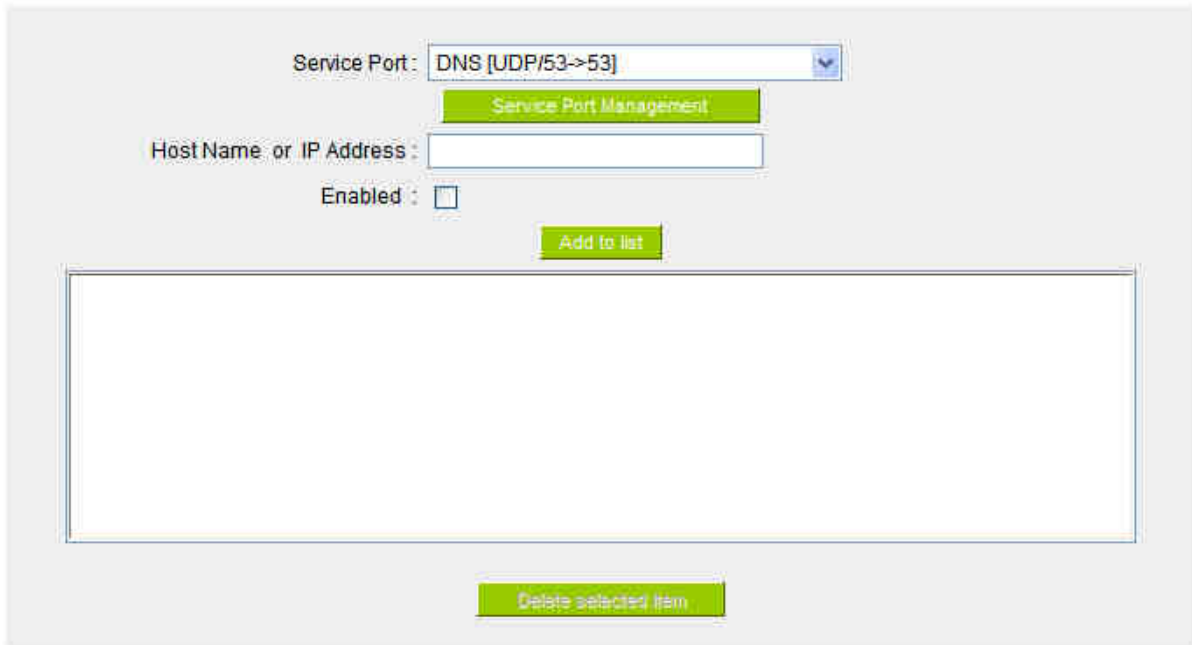

Show Table Apply Cancel

Service Port :	Select the UPnP service number default list here; for example, WWW is 80~80, FTP is 21~21. Please refer to the default service number list.
Host Name or IP Address :	Input the Intranet virtual IP address or name that maps with UPnP such as 192.168.1.100.
Enabled :	Activate this function.
Service Port Management :	Add or remove service ports from the management list.
Add to List :	Add to active service content.

Delete Selected Item :	Remove selected services.
Show Table :	This is a list which displays the current active UPnP functions.
Apply :	Click "Apply" to save the network configuration modification.
Cancel :	Click "Cancel" to leave without making any change.

12.3 Routing

In this chapter we introduce the Dynamic Routing Information Protocol and Static Routing Information Protocol.

Dynamic Routing

Working Mode :	<input checked="" type="radio"/> Gateway <input type="radio"/> Router
RIP :	<input type="radio"/> Enabled <input checked="" type="radio"/> Disabled
Receive RIP versions :	Both RIP v1 and v2
Transmit RIP versions :	RIPv2 - Broadcast

Static Routing

Dest IP : . . .
 Subnet Mask : . . .
 Gateway : . . .
 Hop Count :
 Interface : LAN

12.3.1 Dynamic Routing

The abbreviation of Routing Information Protocol is RIP. There are two kinds of RIP in the IP environment – RIP I and RIP II. Since there is usually only one router in a network, ordinarily just Static Routing will be used. RIP is used when there is more than one router in a network, and if an administrator doesn't want to assign a path list one by one to all of the routers, RIP can help

refresh the paths.

RIP is a very simple routing protocol, in which Distance Vector is used. Distance Vector determines transmission distance in accordance with the number of routers, rather than based on actual session speed. Therefore, sometimes it will select a path through the least number of routers, rather than through the fastest routers.

Dynamic Routing

Working Mode :	<input checked="" type="radio"/> Gateway <input type="radio"/> Router
RIP :	<input type="radio"/> Enabled <input checked="" type="radio"/> Disabled
Receive RIP versions :	Both RIP v1 and v2
Transmit RIP versions :	RIPv2 - Broadcast

Working Mode :	Select the working mode of the device: NAT mode or router mode.
RIP :	Click "Enabled" to open the RIP function.
Receive RIP versions :	Use Up/Down button to select one of " None, RIPv1, RIPv2, Both RIPv1 and v2 " as the " TX " function for transmitting dynamic RIP.
Transmit RIP versions :	Use Up/Down button to select one of " None, RIPv1, RIPv2-Broadcast, RIPv2-Multicast " as the " RX " function for receiving dynamic RIP.

12.3.2 Static Routing

When there are more than one router and IP subnets, the routing mode for the device should be configured as static routing. Static routing enables different network nodes to seek necessary paths automatically. It also enables different network nodes to access each other. Click the button "**Show Routing Table**" (as in the figure) to display the current routing list.

Static Routing

Dest. IP: . . .
 Subnet Mask: . . .
 Gateway: . . .
 Hop Count:
 Interface:

Dest. IP :	Input the remote network IP locations and subnet that is to be routed. For example, the IP/subnet is 192.168.2.0/255.255.255.0.
Subnet Mask :	
Gateway :	The default gateway location of the network node which is to be routed.
Hop Count :	This is the router layer count for the IP. If there are two routers under the device, users should input "2" for the router layer; the default is "1". (Max. is 15.)
Interface :	This is to select "WAN port" or "LAN port" for network connection location.
Add to List :	Add the routing rule into the list.
Delete Selected Item :	Remove the selected routing rule from the list.
Show Table :	Show current routing table.
Apply :	Click " Apply " to save the network configuration modification
Cancel :	Click " Cancel " to leave without making any changes.

12.4 One to One NAT

As both the device and ATU-R need only one actual IP, if ISP issued more than one actual IP (such as eight ADSL static IP addresses or more), users can map the remaining real IP addresses to the intranet PC virtual IP addresses. These PCs use private IP addresses in the Intranet, but after having One to One NAT mapping, these PCs will have their own public IP addresses.

For example, if there are more than 2 web servers requiring public IP addresses, administrators can map several public IP addresses directly to internal private IP addresses.

Example : Users have five available IP addresses - 210.11.1.1~5, one of which, 210.11.1.1, has been configured as a real IP for WAN, and is used in NAT. Users can respectively configure the other four real IP addresses for Multi-DMZ, as follows:

210.11.1.2 → 192.168.1.3

210.11.1.3 → 192.168.1.4

210.11.1.4 → 192.168.1.5

210.11.1.5 → 192.168.1.6

Attention !

The device WAN IP address can not be contained in the One-to-One NAT IP configuration.

Enabled One to One NAT

Private IP Range Begin : . . .

Public IP Range Begin : . . .

Range Length :

Enabled One to One NAT :	To activate or close the One-to-One NAT function. (Check to activate the function).
Private IP Range Begin :	Input the Private IP address for the Intranet One-to-One NAT function.
Public IP Range Begin :	Input the Public IP address for the Internet One-to-One NAT function.
Range Length :	The numbers of final IP addresses of actual Internet IP addresses. (Please do not include IP addresses in use by WANs.)
Add to List :	Add this configuration to the One-to-One NAT list.
Delete Seleted Item :	Remove a selected One-to-One NAT list.
Apply :	Click " Apply " to save the network configuration modification.
Cancel :	Click " Cancel " to leave without making any changes.

Attention !

One-to-One NAT mode will change the firewall working mode. If this function has been

set up, the Internet IP server or PC which is mapped with a LAN port will be exposed on the Internet. To prevent Internet users from actively connecting with the One-on-One NAT server or PC, please set up a proper denial rule for access, as described Firewall.

12.5 DDNS- Dynamic Domain Name Service

DDNS supports the dynamic web address transfer for QnoDDNS.org.cn、3322.org、DynDNS.org and DtDNS.com. This is for VPN connections to a website that is built with dynamic IP addresses, and for dynamic IP remote control. For example, the actual IP address of an ADSL PPPoE time-based system or the actual IP of a cable modem will be changed from time to time. To overcome this problem for users who want to build services such as a website, it offers the function of dynamic web address transfer. This service can be applied from www.qno.cn/ddns, www.3322.org, www.dyndns.org, or www.dtdns.com, and these are free.

Also, in order to solve the issue that DDNS server is not stable, the device can update the dynamic IP address with different services at the same time.

▶ DDNS

Interface	Dynamic Domain Name	Status	Config.
WAN 1	Dyndns:-- 3322:-- Dtdns:-- Qnoddns:--	Dyndns Disabled 3322 Disabled Dtdns Disabled Qnoddns Disabled	Edit
WAN 2	Dyndns:-- 3322:-- Dtdns:-- Qnoddns:--	Dyndns Disabled 3322 Disabled Dtdns Disabled Qnoddns Disabled	Edit
WAN 3	Dyndns:-- 3322:-- Dtdns:-- Qnoddns:--	Dyndns Disabled 3322 Disabled Dtdns Disabled Qnoddns Disabled	Edit
WAN 4	Dyndns:-- 3322:-- Dtdns:-- Qnoddns:--	Dyndns Disabled 3322 Disabled Dtdns Disabled Qnoddns Disabled	Edit

Select the WAN port to which the configuration is to be edited, for example, WAN 1. Click the hyperlink to enter and edit the settings.

Interface:

DynDNS.org

User Name :	<input type="text"/>	<input type="button" value="Register"/>
Password :	<input type="text"/>	(The Password can't contain 'password')
Dynamic Domain Name :	<input type="text"/>	<input type="text"/>
WAN IP Address :	0.0.0.0	
Status :	DDNS function is disabled or No Internet connection.	

3322.org

User Name :	<input type="text"/>	<input type="button" value="Register"/>
Password :	<input type="text"/>	(The Password can't contain 'password')
Dynamic Domain Name :	<input type="text"/>	<input type="text"/>
WAN IP Address :	0.0.0.0	
Status :	DDNS function is disabled or No Internet connection.	

DtDNS.com

QnoDDNS.org.cn

Interface	This is an indication of the WAN port the user has selected.
DDNS	Check either of the boxes before DynDNS.org, 3322.org, DtDNS.com and QnoDDNS.org.cn to select one of the four DDNS website address transfer functions.
Username	The name which is set up for DDNS. Input a complete website address such as abc.qnoddns.org.cn as a user name for QnoDDNS.
Password	The password which is set up for DDNS.
Dynamic Domain Name	Input the website address which has been applied from DDNS. Examples are abc.dyndns.org or xyz.3322.org.
WAN IP Address	Input the actual dynamic IP address issued by the ISP.
Status	An indication of the status of the current IP function refreshed by DDNS.
Apply	After the changes are completed, click " Apply " to save the network configuration modification.
Cancel	Click " Cancel " to leave without making any changes.

Register for QnoDDNS

- 1 · Please go to Qno website and register the product at <http://www.qno.com.tw>.



HOME > 客戶服務 > 產品註冊

產品註冊

上網完成產品註冊
贈送延長保固3個月!

保固查詢 註冊資料查詢

1. 會員條款
歡迎光臨俠諾科技股份有限公司(以下簡稱Qno)網站,為了保障您的權益,請詳細閱讀以下內容,尤其當您在完成註冊程序後,表示您已同意遵守會員條款的規範,並使用Qno所提供之服務。本站得視必要更新服務條款,不另特別通知。

2. 服務說明
Qno及所屬含<http://www.qno.com.tw>, <http://www.qno.cn> 等網站提供會員資訊、下載、QnoDDNS等多項服務,為取得這些服務,您必須擁有網路連線所需之裝置,並支付相關費用。為了提供專業化和個性化的服務,Qno有可能在您瀏覽Qno的各相關網站時使用Cookie Files儲存及查詢您的相關信息。

3. 智慧財產權
會員必須了解並同意,本站之任何廣告或訊息,包含文字、軟體、音樂、聲音、影像、圖片等均受著作權、商標權、專利權或其他財產權之法律保護,會員不可擅自複製、散發,必須經本站同意或授權才可使用這些資料。

4. 服務之修改
本站有權於任何時間暫時或永久修改、終止本服務(或其任何部分)。無論通知與否,本服務任何修改、暫停或終止,您同意本站對您和任何第三人均不承擔責任。

我已詳細閱讀以上註冊條款,並完全同意該條款中的內容

下一步 不同意

- 2 · Input the e-mail address which users used to register this product and the serial number of the product to log in to the QnoDDNS Service System. Be sure to input an available e-mail address so that the password sent from the system to activate QnoDDNS service can be received after the domain name registration.



The image shows a screenshot of the QNO Dynamic DNS Service Login page. The page features the QNO logo and the text "your future life" in the top right corner. The main heading is "Qno DDNS 俠諾動態域名 Qno Dynamic DNS Service". Below this is a login form titled "Qno Dynamic DNS Service Login" with the following fields: "E-mail:", "序號:" (Serial Number), "驗證圖:" (Verification Image) showing the number "484293", and "驗證碼:" (Verification Code). A link "(序號在哪裡?)" (Where is the serial number?) is provided below the verification code field. A "送出" (Submit) button is at the bottom right of the form. Below the form, there is a link: "還沒註冊嗎? 前往註冊Qno俠諾路由器! (QnoDDNS服務使用教學)". At the bottom, there is a copyright notice: "Copyright © 2007-2008 Qno Technology Inc. All rights reserved." and a license number: "蘇ICP備07008524號".

3 · Rules for Applying a Domain Name:

- The Domain should have at least 4 letters and no more than 63 letters.
- The Domain name should only consist of a-z (lowercase letter) and 0-9 (numerals) and the first character should be an English letter.
- For products with two WANs, users can apply no more than two DDNS configurations.
- For products with two WANs, users can apply no more than two DDNS configurations.
- For products with eight WANs (or over), users can apply no more than four DDNS configurations.

:: 使用者資料 ::

姓名	
Email	
序號	
型號	
Wan數量	
目前登入IP	
伺服器時間	

:: 申請規則 ::

1. 如果您申請QnoDDNS服務，代表"您無條件同意" [Qno俠諾科技動態網域名稱服務條款](#)。
2. "使用者名稱" 最少需要4個字，最多63個字(4-63個字)。
3. "使用者名稱" 只能由a-z(英文小寫)、0-9(數字)所組成，且第一個字需為英文字母。
4. "使用者名稱" 內不允許含有 'qno '、'dns '的英文字母在內！
5. "使用者名稱" 不得有特殊符號(例如："."；"-"；"_"...等等)。([範例](#))
6. 2 Wan 系列產品最多申請 2 組DDNS設定。
7. 4 Wan 系列產品最多申請 4 組DDNS設定。
8. 8 Wan 系列產品最多申請 4 組DDNS設定。
9. 設定 QnoDDNS 之前，請先確認產品之 "系統時間" 正確，請參考 [系統時間](#)、[時間設置](#)。
10. 如果您無法透過網路使用NTP服務來更新路由器時間，請參考 [伺服器時間](#)來 [手動更新](#)。
11. Qno NTP Server：1. [ntp.qnoddns.org.cn](#) 2. [ntp.ddns.org.cn](#)
12. 其他NTP Server：1. [香港天文台](#) 2. [台灣中華電信研究所](#) 3. [國際亞洲NTP Server](#)。
13. 其他注意事項請參考 [QnoDDNS服務使用教學](#)。

:: 使用者名稱測試 ::

已輸入0個字

測試	使用者名稱： <input type="text"/>	網域名稱： <input type="text" value="qnoddns.org.cn"/>	<input type="button" value="送出"/>	<input type="button" value="重設"/>
----	-----------------------------	---	-----------------------------------	-----------------------------------

尚可申請 4 組DDNS

已輸入0個字

第1組	使用者名稱： <input type="text"/>	網域名稱： <input type="text" value="qnoddns.org.cn"/>	<input type="button" value="申請"/>
-----	-----------------------------	---	-----------------------------------

已輸入0個字

第2組	使用者名稱： <input type="text"/>	網域名稱： <input type="text" value="qnoddns.org.cn"/>	
-----	-----------------------------	---	--

已輸入0個字

第3組	使用者名稱： <input type="text"/>	網域名稱： <input type="text" value="qnoddns.org.cn"/>	
-----	-----------------------------	---	--

已輸入0個字

第4組	使用者名稱： <input type="text"/>	網域名稱： <input type="text" value="qnoddns.org.cn"/>	
-----	-----------------------------	---	--

12.6 MAC Clone

Some ISP will request for a fixed MAC address (network card physical address) for distributing IP address, which is mostly suitable for cable mode users. Users can input the network card physical address (MAC address: 00-xx-xx-xx-xx-xx) here. The device will adopt this MAC address when requesting IP address from ISP.

MAC Clone

Interface	MAC Address	Config.
WAN 1	00-0c-41-00-00-02	Edit
WAN 2	00-0c-41-00-00-03	Edit
WAN 3	00-0c-41-00-00-04	Edit
WAN 4	00-0c-41-00-00-05	Edit

Select the WAN port to which the configuration is to be edited; click the hyperlink to enter and edit its configuration. Users can input the MAC address manually. Press "Apply" to save the setting, and press "Cancel" to remove the setting.

Default MAC address is the WAN MAC address.

Interface:

User Defined WAN MAC Address :	<input checked="" type="radio"/> <input type="text" value="00"/> <input type="text" value="0c"/> <input type="text" value="41"/> <input type="text" value="00"/> <input type="text" value="00"/> <input type="text" value="02"/> (Default: 00-0c-41-00-00-02)
MAC Address from this PC :	<input type="radio"/> 00-16-e6-50-13-32

XIII. System Tool

This chapter introduces the management tool for controlling the device and testing network connection.

For security consideration, we strongly suggest to change the password. Password and Time setting is in Chapter 5.2.

13.1 Diagnostic

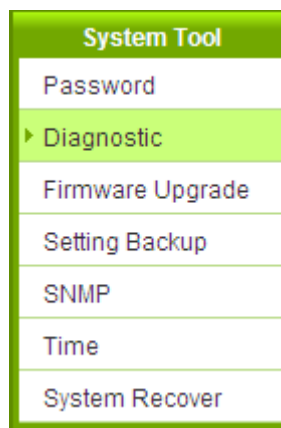

The device provides a simple online network diagnostic tool to help users troubleshoot network-related problems. This tool includes **DNS Name Lookup** (Domain Name Inquiry Test) and **Ping (Packet Delivery/Reception Test)**.

DNS Name Lookup Ping

Ping host or IP address :

DNS Name lookup

On this test screen, please enter the host name of the network users want to test. For example, users may enter www.abc.com and press "Go" to start the test. The result will be displayed on this page.

DNS Name Lookup Ping

Look up the name :
Name: www.qno.com.tw
Address: 59.124.180.50

Ping

DNS Name Lookup Ping

Ping host or IP address :
Status: **Test Succeeded**
Packets: 4/4 transmitted, 4/4 received, 0% loss
Round Trip Time: Minimum = 2 ms
Maximum = 2 ms
Average = 2 ms

This item informs users of the status quo of the outbound session and allows the user to know the existence of computers online.

On this test screen, please enter the host IP that users want to test such as 192.168.5.20. Press "Go" to start the test. The result will be displayed on this screen.

13.2 Firmware Upgrade

Users may directly upgrade the device firmware on the Firmware Upgrade page. Please confirm all information about the software version in advance. Select and browse the software file, click "**Firmware Upgrade Right Now**" to complete the upgrade of the designated file.

Note !

Please read the warning before firmware upgrade.

Users must not exit this screen during upgrade. Otherwise, the upgrade may fail.

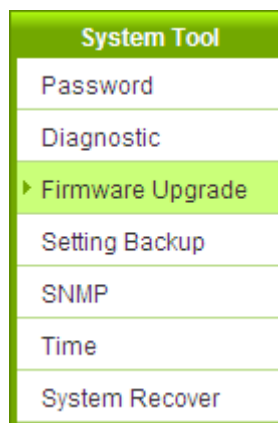

Firmware Upgrade



Warning : 1. When choosing previous firmware versions, all settings will restore back to default value.
2. Upgrading firmware may take a few minutes, please don't turn off the power or press the Reset button.
3. Please don't close the window or disconnect the link, during the upgrade process.

13.3 Setting Backup

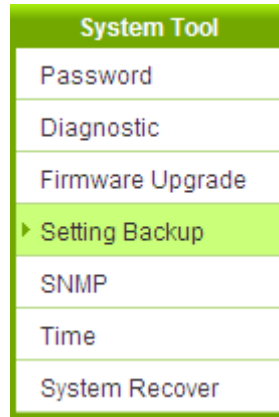

Import Configuration File



Export Configuration File



Import Configuration File :

This feature allows users to integrate all backup content of parameter settings into the device. Before upgrade, confirm all information about the software version. Select and browse the backup parameter file: "config.exp." Select the file and click "**Import**" to import the file.

Export Configuration File :

This feature allows users to backup all parameter settings. Click "Export" and select the location to save the "config.exp" file.

13.4 SNMP

Simple Network Management Protocol (SNMP) refers to network management communications protocol and it is also an important network management item. Through this SNMP communications protocol, programs with network management (i.e. SNMP Tools-HP Open View) can help communications of real-time management. The device supports standard SNMP v1/v2c and is consistent with SNMP network management software so as to get hold on to the operation of the online devices and the real-time network information.

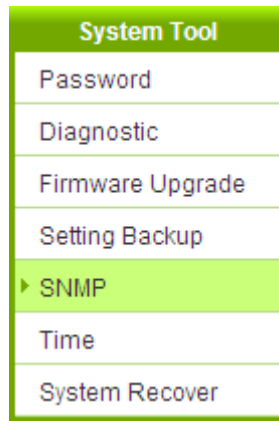

SNMP

Enabled

System Name :	4_WAN_QVM_Router
System Contact :	
System Location :	
Get Community Name :	public
Set Community Name :	private
Trap Community Name :	public
Send SNMP Trap to :	

Apply Cancel

Enabled :	Activate SNMP feature. The default is activated.
System Name :	Set the name of the device such as 4WANRouter.
System Contact :	Set the name of the person who manages the device (i.e. John).
System Location :	Define the location of the device (i.e. Taipei).
Get Community Name :	Set the name of the group or community that can view the device SNMP data. The default setting is "Public".
Set Community Name :	Set the name of the group or community that can receive the device SNMP data. The default setting is "Private".
Trap Community Name :	Set user parameters (password required by the Trap-receiving host computer) to receive Trap message.
Send SNMP Trap to :	Set one IP address or Domain Name for the Trap-receiving host computer.
Apply :	Press " Apply " to save the settings.
Cancel :	Press " Cancel " to keep the settings unchanged.

13.5 System Recover

Users can restart the device with System Recover button.

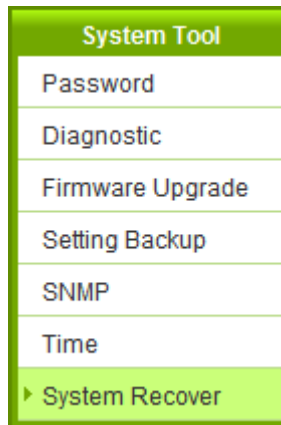

▶ Restart

Restart Router

▶ Factory Default

Return to Factory Default Setting

Restart

As the figure below, if clicking "Restart Router" button, the dialog block will pop out, confirming if users would like to restart the device.

▶ Restart

Restart Router

▶ Factory Default



Return to Factory Default Setting

If clicking "Return to Factory Default Setting, the dialog block will pop out, if the device will return to factory default.

 **Factory Default**



XIV. Log

From the log management and look up, we can see the relevant operation status, which is convenient for us to facilitate the setup and operation.

14.1 System Log

Its system log offers three options: system log, E-mail alert, and log setting.

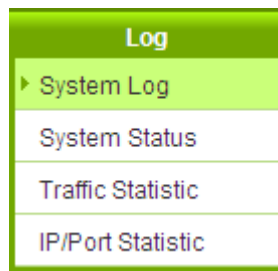

Syslog Server

Enabled

E-mail Alert

Enabled

Log Setting

Alert Log		
<input type="checkbox"/> Syn Flooding	<input type="checkbox"/> IP Spoofing	<input type="checkbox"/> Win Nuke
<input type="checkbox"/> Ping Of Death	<input checked="" type="checkbox"/> Unauthorized Login Attempt	

General Log		
<input checked="" type="checkbox"/> System Error Messages	<input type="checkbox"/> Deny Policies	<input type="checkbox"/> Allow Policies
<input checked="" type="checkbox"/> Configuration Changes	<input checked="" type="checkbox"/> Authorized Login	

View System Log	Outgoing Packet Log	Incoming Packet Log	Clear Log Now
-----------------	---------------------	---------------------	---------------

System Log

Syslog Server

Enabled

Host Name : (Name or IP Address)

Enabled :	If this option is selected, the System Log feature will be enabled.
-----------	---

Host Name :	The device provides external system log servers with log collection feature. System log is an industrial standard communications protocol. It is designed to dynamically capture related system message from the network. The system log provides the source and the destination IP addresses during the connection, service number, and type. To apply this feature, enter the system log server name or the IP address into the empty "system log server" field.
-------------	--

E-mail Alert

 **E-mail Alert**

Enabled

Mail Server :	<input type="text"/>	(Name or IP Address)
E-mail :	<input type="text"/>	
Log Queue Length :	<input type="text" value="50"/>	entries
Log Time Threshold :	<input type="text" value="10"/>	minutes

Send Log to E-mail

Enabled :	If this option is selected, E-mail Warning will be enabled.
Mail Server :	If users wish to send out all the logs, please enter the E-mail server name or the IP address; for instance, mail.abc.com .
E- mail :	This is set as system log recipient email address such as abc@mail.abc.com .
Log Queue Length :	Set the number of Log entries, and the default entry number is 50. When this defined number is reached, it will automatically send out the log mail.

Log Time Threshold :	Set the interval of sending the log, and the default is set to 10 minutes. Reaching this defined number, it will automatically send out the Mail log. The device will detect which parameter (either entries or intervals) reaches the threshold first and send the log message of that parameter to the user.
Send Log to E- mail :	Users may send out the log right away by pressing this button.

Log Setting

▶ Log Setting

Alert Log

Syn Flooding

IP Spoofing

Win Nuke

Ping Of Death

Unauthorized Login Attempt

General Log

System Error Messages

Deny Policies

Allow Policies

Configuration Changes

Authorized Login

View System Log

Outgoing Packet Log

Incoming Packet Log

Clear Log Now

Alert Log

The device provides the following warning message. Click to activate these features: Syn Flooding, IP Spoofing, Win Nuke, Ping of Death / Unauthorized Login Attempt.

Syn Flooding :	Bulky syn packet transmission in a short time causes the overload of the system storage of record in connection information.
IP Spoofing :	Through the packet sniffing, hackers intercept data transmitted on the network. After they access the information, the IP address from the sender is changed so that they can access the resource in the source system.
Win Nuke :	Servers are attacked or trapped by the Trojan program.

Ping of Death :	The system fails because the sent data exceeds the maximum packet that can be handled by the IP protocol.
Unauthorized Login :	If intruders into the device are identified, the message will be sent to the system log.

General Log

The device provides the following warning message. Click to activate the feature. System error message, blocked regulations, regulation of passage permission, system configuration change and registration verification.

System Error Message :	Provides the system log with all kinds of error messages. For example, wrong settings, occurrence of abnormal functions, system reactivation, disconnection of PPPoE and so on.
Deny Policies :	If remote users fail to enter the system because of the access rules; for instance, message will be recorded in the system log.
Allow Policies :	If remote users enter the system because of compliance with access rules; for instance, message will be recorded in the system log.
Configuration Change :	When the system settings are changed, this message will be sent back to the system log.
Authorized Login :	Successful entry into the system includes login from the remote end or from the LAN into this device. These messages will be recorded in the system log.

The following is the description of the four buttons allowing online inquiry into the log.

View System Log :

This option allows users to view system log. The message content can be read online via the device. They include **All Log**, **System Log**, **Access Log**, **Firewall Log**, and **VPN log**, which is illustrated as below.

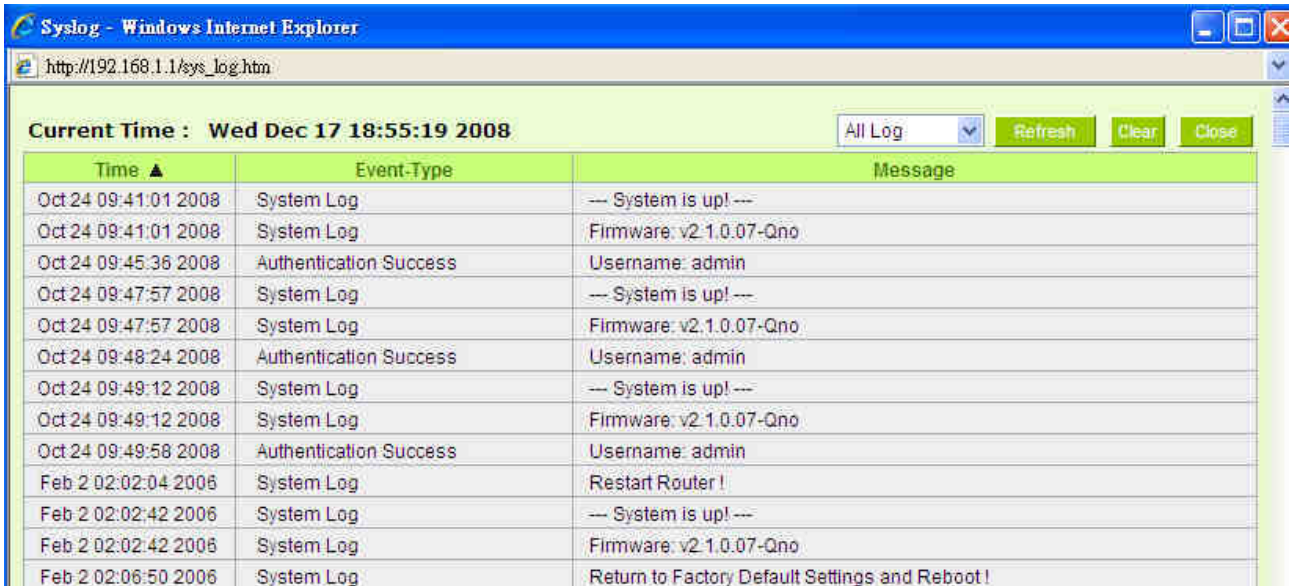

Current Time : Wed Dec 17 18:55:19 2008

Time ▲	Event-Type	Message
Oct 24 09:41:01 2008	System Log	-- System is up! --
Oct 24 09:41:01 2008	System Log	Firmware: v2.1.0.07-Qno
Oct 24 09:45:36 2008	Authentication Success	Username: admin
Oct 24 09:47:57 2008	System Log	-- System is up! --
Oct 24 09:47:57 2008	System Log	Firmware: v2.1.0.07-Qno
Oct 24 09:48:24 2008	Authentication Success	Username: admin
Oct 24 09:49:12 2008	System Log	-- System is up! --
Oct 24 09:49:12 2008	System Log	Firmware: v2.1.0.07-Qno
Oct 24 09:49:58 2008	Authentication Success	Username: admin
Feb 2 02:02:04 2006	System Log	Restart Router !
Feb 2 02:02:42 2006	System Log	-- System is up! --
Feb 2 02:02:42 2006	System Log	Firmware: v2.1.0.07-Qno
Feb 2 02:06:50 2006	System Log	Return to Factory Default Settings and Reboot!

Outgoing Packet Log :

View system packet log which is sent out from the internal PC to the Internet. This log includes LAN IP, destination IP, and service port that is applied. It is illustrated as below.



Time ▲	Event-Type	Message
Feb 6 03:46:03 2006	Connection Refused - Policy violation	UDP 192.168.1.100:7464->77.239.233.64:20301 on ixp2
Feb 6 03:46:06 2006	Connection Refused - Policy violation	UDP 192.168.1.100:7464->84.10.118.17:10682 on ixp7
Feb 6 06:27:54 2006	Connection Refused - Policy violation	TCP 192.168.1.1:80->192.168.1.100:1224 on ixp0
Feb 6 08:18:58 2006	Connection Refused - Policy violation	TCP 192.168.1.101:18195->163.253.104.148:1234 on ixp1
Feb 6 08:19:53 2006	Connection Refused - Policy violation	TCP 192.168.1.101:51671->3.139.58.12:1234 on ixp1

Incoming Packet Log :

View system packet log of those entering the firewall. The log includes information about the external source IP addresses, destination IP addresses, and service ports. It is illustrated as below.



Time ▲	Event-Type	Message
Feb 6 02:34:31 2006	Connection Refused - Policy violation	UDP 192.168.2.1:67->255.255.255.255:68 on ixp2
Feb 6 02:57:54 2006	Connection Refused - Policy violation	UDP 192.168.1.100:137->192.168.1.255:137 on ixp0
Feb 6 03:06:39 2006	Connection Refused - Policy violation	UDP 192.168.2.1:67->192.168.2.102:68 on ixp2
Feb 6 03:15:31 2006	Connection Refused - Policy violation	UDP 192.168.2.1:67->192.168.2.100:68 on ixp4
Feb 6 03:45:58 2006	Connection Refused - Policy violation	UDP 192.168.1.100:7464->75.128.47.253:27220 on ixp0
Feb 6 03:46:00 2006	Connection Refused - Policy violation	UDP 192.168.1.100:7464->91.153.161.189:27310 on ixp0
Feb 6 03:46:02 2006	Connection Refused - Policy violation	UDP 192.168.1.100:7464->24.160.250.156:19343 on ixp0

Clear Log Now :

This feature clears all the current information on the log.

14.2 System Statistic

The device has the real-time surveillance management feature that provides system current operation information such as port location, device name, current WAN link status, IP address, MAC address, subnet mask, default gateway, DNS, number of received/ sent/ total packets , number of received/ sent/ total Bytes, Received and Sent Bytes/Sec., total number of error packets received, total number of the packets dropped, number of session, number of the new Session/Sec., and upstream as well as downstream broadband usage (%).



System Status

[Next Page>>](#)

Interface	WAN 1	WAN 2	WAN 3	WAN 4
Device Name	ixp1	ixp2	ixp3	ixp4
Link Status	Down	Connected	Down	Down
IP Address	0.0.0.0	192.168.4.138	0.0.0.0	0.0.0.0
MAC Address	00-0c-41-00-00-02	00-0c-41-00-00-03	00-0c-41-00-00-04	00-0c-41-00-00-05
Subnet Mask	0.0.0.0	255.255.254.0	0.0.0.0	0.0.0.0
Default Gateway	0.0.0.0	192.168.4.1	0.0.0.0	0.0.0.0
DNS Server	0.0.0.0	192.168.5.21	0.0.0.0	0.0.0.0
Network Service Detection	Test Failed	Test Succeeded	Test Failed	Test Failed
Receive Packets Count	0	0	0	0
Transmit Packets Count	0	0	0	0
Total Packets Count	0	0	0	0
Receive Packets Byte Count	0	93053577	0	0
Transmit Packets Byte Count	0	25338543	0	0
Total Packets Byte Count	0	118392120	0	0
Receive Byte/Sec	0	640	0	0
Transmit Byte/Sec	0	0	0	0
Error Packets Count	0	0	0	0
Dropped Packets Count	0	0	0	0
Session	0	9	0	0
New Session/Sec	0	0	0	0
Upstream Bandwidth Usage(%)	0	0	0	0
Downstream Bandwidth Usage (%)	0	0	0	0

Refresh

14.3 Traffic Statistic

Six messages will be displayed on the **Traffic Statistic** page to provide better traffic management and control.

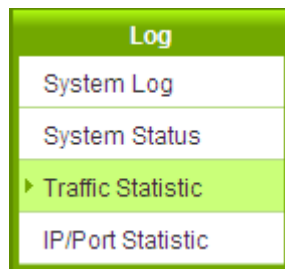

▶ Traffic Statistic

Enabled

Sorting Type: By Inbound IP Address ▼

Source IP	bytes/sec	%
192.168.1.100	609	100

Refresh

By Inbound IP Address :

The figure displays the source IP address, bytes per second, and percentage.

▶ Traffic Statistic

Enabled

Sorting Type: By Outbound IP Address ▼

Source IP	bytes/sec	%
192.168.1.100	1619	99
192.168.4.138	4	0

Refresh

By outbound IP Address :

The figure displays the source IP address, bytes per second, and percentage.

Traffic Statistic

Enabled

Sorting Type: By Outbound Port

Protocol	Dest. Port	bytes/sec	%
TCP	http(80)	85	91
TCP	1122	8	8

Refresh

By Outbound Port :

The figure displays the network protocol type, destination IP address, bytes per second, and percentage.

Traffic Statistic

Enabled

Sorting Type: By Inbound Port

Protocol	Dest. Port	bytes/sec	%
TCP	1122	49	100

Refresh

By Inbound Port :

The figure displays the network protocol type, destination IP address, bytes per second, and percentage.

Traffic Statistic

Enabled

Sorting Type : By Outbound Session

Source IP	Protocol	Source Port	Dest. IP	Dest. Port	bytes/sec	%
192.168.5.126	TCP	1096	192.168.1.100	1336	4	100

Refresh

By Outbound Session :

The figure displays the source IP address, network protocol type, source port, destination IP address, destination port, bytes per second and percentage.

Traffic Statistic

Enabled

Sorting Type : By Inbound Session

Dest. IP	Protocol	Dest. Port	Source IP	Source Port	bytes/sec	%
192.168.1.100	TCP	1713	192.168.5.126	1122	14	61
192.168.1.100	TCP	1710	192.168.5.126	1096	4	18

Refresh

By Inbound Session :

The figure displays the source IP address, network protocol type, source port, destination IP address, destination port, bytes per second and percentage.

14.4 IP/ Port Statistic

The device allows administrators to inquire a specific IP (or from a specific port) about the addresses that this IP had visited, or the users (source IP) who used this service port. This facilitates the identification of websites that needs authentication but allows a single WAN port rather than Multi-WANs. Administrators may find out the destination IP for protocol binding to solve this login problem. For example, when certain port software is denied, inquiring about the IP address of this specific software server port may apply this feature. Moreover, to find out BT or P2P software, users may select this feature to inquire users from the port.

Log

- System Log
- System Status
- Traffic Statistic
- ▶ IP/Port Statistic

▶ **IP/Port Statistic**

Enabled

Search Type: Service Port Service Port: 0 Search

Source IP	Protocol	Source Port	Interface	Dest. IP	Dest. Port	Downstream Bandwidth Bytes/Sec	Upstream Bandwidth Bytes/Sec
-----------	----------	-------------	-----------	----------	------------	--------------------------------	------------------------------

Refresh

Specific IP Status :

Enter the IP address that users want to inquire, and then the entire destination IP connected to remote devices as well as the number of ports will be displayed.

▶ **IP/Port Statistic**

Enabled

Search Type: IP Address IP Address: 192 . 168 . 1 . 100 Search

Source IP	Protocol	Source Port	Interface	Dest. IP	Dest. Port	Downstream Bandwidth Bytes/Sec	Upstream Bandwidth Bytes/Sec
192.168.1.100	TCP	1290	WAN2	207.46.111.14	80	0	0
192.168.1.100	TCP	1591	WAN2	192.168.4.194	4603	0	0
192.168.1.100	TCP	1703	WAN2	192.168.5.21	49156	0	0
192.168.1.100	TCP	1710	WAN2	192.168.5.126	1096	0	0
192.168.1.100	TCP	1713	WAN2	192.168.5.126	1122	0	0
192.168.1.100	TCP	1718	WAN2	192.168.5.21	49156	0	0
192.168.1.100	TCP	1751	WAN2	192.168.5.24	445	0	0
192.168.1.100	TCP	1763	WAN2	192.168.5.21	389	0	0

Refresh

Specific Port Status :

Enter the service port number in the field and IP that are currently used by this port will be displayed.

IP/Port Statistic

Enabled

Search Type: Service Port:

Source IP	Protocol	Source Port	Interface	Dest. IP	Dest. Port	Downstream Bandwidth Bytes/Sec	Upstream Bandwidth Bytes/Sec
192.168.1.100	TCP	1290	WAN2	207.46.111.14	80	217	85
192.168.1.100	TCP	1944	WAN2	203.69.138.19	80	0	0

XV. Log out

On the top right corner of the web- based UI, there is a Logout button. Click on it to log out of the web- based UI. To enter next time, open the Web browser and enter the IP address, user name and password to log in.



Appendix I: User Interface and User Manual Chapter Cross Reference

This appendix is to show the corresponding index for each chapter and user interface. Users can find how to setup quickly and understand the VPN Router capability at the same time.

VPN Router overall interface is as below.

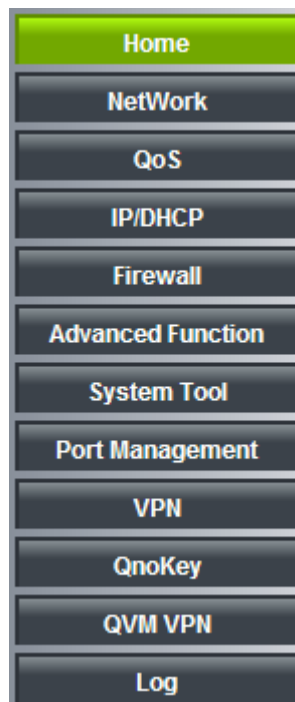

Category	Sub- category	Chapter
Home		V. Device Spec Verification, Status Display and Login Password and Time Setting 5.1 Home
Basic Setting		VI. Network
	Network Connection	6.1 Network Connection
	Traffic Management	6.2 Multi- WAN Setting
	Protocol Binding	6.2 Multi- WAN Setting
QoS		VIII. QoS

	Bandwidth Management	8.1 (QoS) 8.3 Bandwidth Management
	Session Control	8.2 Session Limit
IP/DHCP		VII. Port Management
	Setup	7.3 DHCP/ IP
	Status	7.4 DHCP Status
	IP & MAC Binding	7.5 IP & MAC Binding
	IP Grouping	7.6 IP Grouping
Firewall		IX. Firewall
	General Policy	9.1 General Policy 9.2 Restricted Application
	Access Rule	9.3 Access Rule
	Content Filter	9.4 Content Filter
Advanced Function		XII. Advanced Setting
	DMZ/Forwarding	12.1 DMZ Host/ Port Range Forwarding
	UPnP	12.2 UPnP- Universal Plug and Play
	Routing	12.3 Routing
	One to One NAT	12.4 One to One NAT
	DDNS	12.5 DDNS
	MAC Clone	12.6 MAC Clone
System Tool		XIII. System Tool V. Device Spec Verification, Status Display and Login Password and Time Setting
	Password	5.2 Change and Set Login Password and Time
	Diagnostic	13.1 Diagnostic
	Firmware Upgrade	13.2 Firmware Upgrade
	Setting Backup	13.3 Setting Backup
	SNMP	13.4 SNMP
	Time	5.2 Change and Set Login Password and Time
	System Recover	13.5 System Recover
Port Management		VII. Port Management

	Setup	7.1 Setup
	Status	7.2 Status
VPN		X. VPN
	Summary	10.1.1 Summary
	Gateway to Gateway	10.1.2.1 Gateway to Gateway
	Client to Gateway	10.1.2.2 Client to Gateway
	PPTP Setup	10.1.3 PPTP Setup
	PPTP Status	10.1.3 PPTP Status
	VPN Pass Through	10.1.4 VPN Pass Through
QnoKey		10.2 QnoKey
	Summary	10.2.1 -10.2.3 QnoKey Group and Client
QVM VPN		10.3 QVM VPN
	QVM Setup	10.3.1 QVM VPN Server Setting 10.3.3 QVM VPN Client Setting
	QVM Status	10.3.2 QVM Status
Log		XIV. Log
	System Log	14.1 System Log
	System Status	14.2 System Status
	Traffic Statistic	14.3 Traffic Statistic
	IP/Port statistic	14.4 IP/Port statistic

Appendix II : Troubleshooting

(1) Block BT Download

To block BT and prevent downloading by users, go to the "Firewall -> Content Filter" and select "Enable Website Block by Keywords," followed by the input of "torrent." This will prevent the users from downloading.

- Accept Allowed Domains
- Block Forbidden Domains

Forbidden Domains

Enabled

Website Blocking by Keywords

Enabled

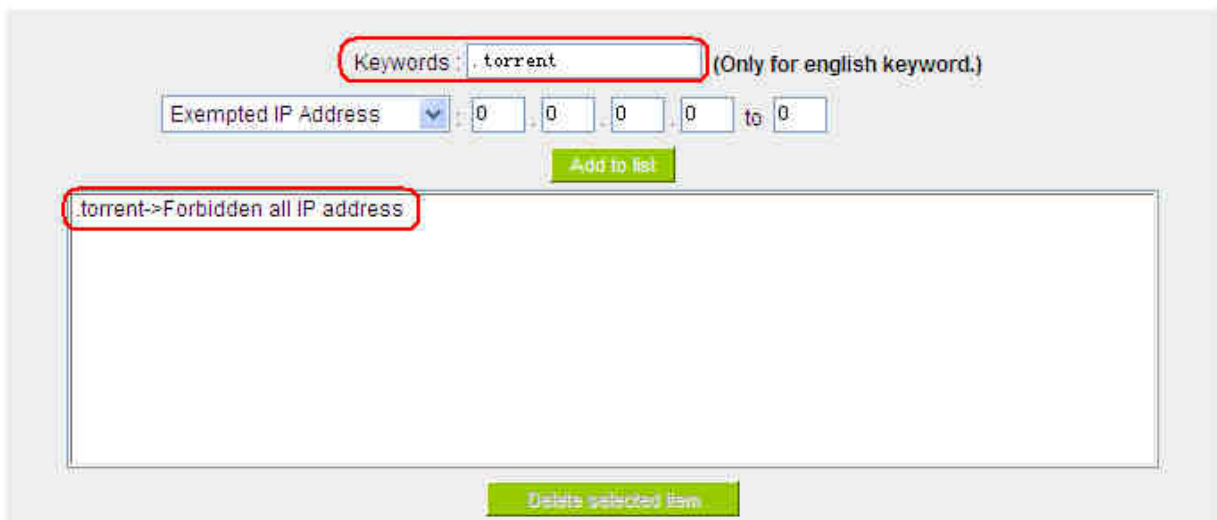

Keywords : (Only for english keyword.)

Exempted IP Address to

(2) Shock Wave and Worm Virus Prevention

Since many users have been attacked by Shock Wave and Worm viruses recently, the internet transmission speed was brought down and the Session bulky increase result in the massive processing load of the device. The following guides users to block this virus' corresponding port for prevention.

- a. Add this TCP135-139, UDP135-139 and TCP445 Port.

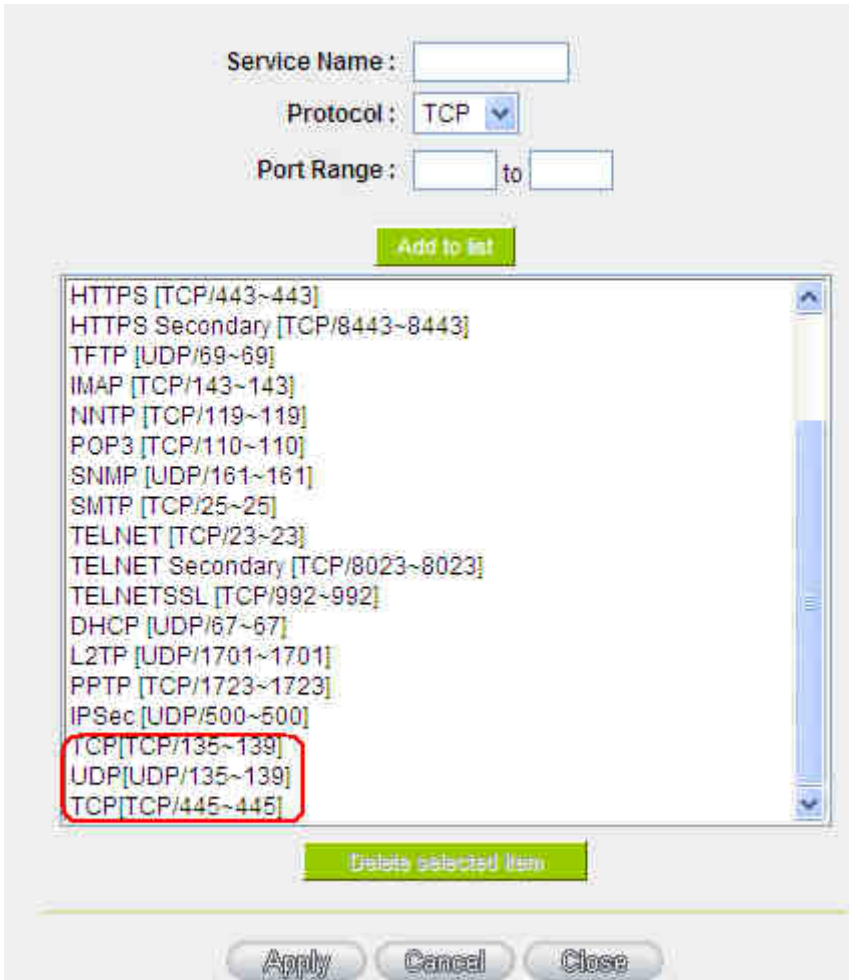

Service Name:

Protocol: TCP

Port Range: to

Add to list

- HTTPS [TCP/443~443]
- HTTPS Secondary [TCP/8443~8443]
- TFTP [UDP/69~69]
- IMAP [TCP/143~143]
- NNTTP [TCP/119~119]
- POP3 [TCP/110~110]
- SNMP [UDP/161~161]
- SMTP [TCP/25~25]
- TELNET [TCP/23~23]
- TELNET Secondary [TCP/8023~8023]
- TELNETSSL [TCP/992~992]
- DHCP [UDP/67~67]
- L2TP [UDP/1701~1701]
- PPTP [TCP/1723~1723]
- IPSec [UDP/500~500]
- TCP[TCP/135~139]**
- UDP[UDP/135~139]**
- TCP[TCP/445~445]**

Delete selected item

Apply Cancel Close

- b. Use the "Access Rule" in the firewall and set to block these three ports.

Access Rule

Action :	Deny
Service Port :	TCP[TCP/135~139] Service Port Management
Log :	No log
Interface :	Any
Source IP :	Any
Dest. IP :	Any

Scheduling

Apply this rule	Always	:	:	to	:	:	(24-Hour Format)
<input type="checkbox"/> Everyday	<input type="checkbox"/> Sun	<input type="checkbox"/> Mon	<input type="checkbox"/> Tue	<input type="checkbox"/> Wed	<input type="checkbox"/> Thu	<input type="checkbox"/> Fri	<input type="checkbox"/> Sat

Use the same method to add UDP [UDP135~139] and TCP [445~445] Ports.

c. Enhance the priority level of these three to the highest.

Jump to / 2 Page entries per page [Next Page>>](#)

Priority	Enabled	Action	Service Port	Interface	Source IP	Dest. IP	Control Time	Day	Edit	Delete
1	<input checked="" type="checkbox"/>	Deny	TCP [445]	*	Any	Any	Always		Edit	
2	<input checked="" type="checkbox"/>	Deny	UDP [135]	*	Any	Any	Always		Edit	
3	<input checked="" type="checkbox"/>	Deny	TCP [135]	*	Any	Any	Always		Edit	
	<input checked="" type="checkbox"/>	Allow	All Traffic [*]	LAN	Any	Any	Always			
	<input checked="" type="checkbox"/>	Deny	All Traffic [*]	WAN1	Any	Any	Always			

(3) Block QQLive Video Broadcast Setting

QQLive Video broadcast software is a stream media broadcast software. Many clients are bothered by the same problem: When several users apply QQLive Video broadcast software, a greater share of the bandwidth is occupied, thus overloading the device. Therefore, the device responds more slowly or is paralyzed. If the login onto the QQLive Server is blocked, the issue can be resolved. The following relates to Qno products and provides users with solutions by introducing users how to set up the device.

- a). Log into the device web- based UI, and enter "Firewall -> Access Rule'.

Access Rule

Action:	Deny
Service Port:	All Traffic [TCP&UDP/1~65535]
Log:	No log
Interface:	Any
Source IP:	Any
Dest. IP:	Single 121 . 14 . 75 . 155

Scheduling

Apply this rule	Always	: : to : : (24-Hour Format)					
<input type="checkbox"/> Everyday	<input type="checkbox"/> Sun	<input type="checkbox"/> Mon	<input type="checkbox"/> Tue	<input type="checkbox"/> Wed	<input type="checkbox"/> Thu	<input type="checkbox"/> Fri	<input type="checkbox"/> Sat

b). Click "Add New Rule" under "Access Rule" page. Select "Deny" in "Action" under the "Service" rule setting, followed by the selection of "All Traffic [TCP&UDP/1~65535]" from "the service" and select "Any" for Interface, "Any" for source IP address (users with relevant needs may select either "Single" or "Range" to block any QQLive login by using one single IP or IP range), followed by the selection of "Single" of the "Dest. IP and enter the IP address as 121.14.75.155" for the QQLive Server (note that there are more than one IP address for

QQLive server. Repeated addition may be needed). Lastly, select "Always" under the Scheduling setting so that the QQLive Login Time can be set. (If necessary, specific time setting may be undertaken). Click "Apply" to move to the next step.

c). Input the following IP address in **Dest. IP** with repeat operation.

121.14.75.115

60.28.234.117

60.28.235.119

222.28.155.17

QQ LiveVersion : QQ Live 2008 (7.0.4017.0)

Tested on: 2008-07-29

After repeated addition, users may see the links to the QQLive Server blocked. Click "Apply" to block QQLive video broadcast.

(4) ARP Virus Attack Prevention

1. ARP Issue and Information

Recently, many cyber cafes in China experienced disconnection (partially or totally) for a short period of time, but connection is resumed quickly. This is caused by the clash with MAC address. When virus-contained MAC mirrors to such NAT equipments as host devices, there is complete disconnection within the network. If it mirrors to other devices of the network, only devices of this affected network have problems. This happens mostly to legendary games especially those with private servers. Evidently, the network is attacked by ARP, which aims to crack the encryption method. By doing so, they hackers may intercept the packet data and user information through the analysis of the game's communication protocol. Through the spread of this virus, the detailed information of the game players within the local network can be obtained. Their account and information are stolen. The following describes how to prevent such virus attack.

First, let us get down to the definition of ARP (Address Resolution Protocol). In LAN, what is actually transmitted is "frame", in which there is MAC address of the destination host device. So-called "Address Analysis" refers to the transferring process of the target IP address into the target MAC address before the host sends out the frame. The basic function of ARP protocol aims to inquire the MAC address of the target equipment via the IP address of the target equipment so as to facilitate the communications.

The Working Principle of ARP Protocol: Computers with TCP/IP protocol have an ARP cache, in which the IP address corresponds to the MAC address (as illustrated).

IP Address	MAC
192.168.1.1	00-0f-3d-83-74-28
192.168.1.2	00-aa-00-62-c5-03
192.168.1.3	03-aa-01-75-c3-06
.....

For example, host A (192.168.1.5) transmits data to Host B (192.168.1.1). Transmitting data, Host A searches for the destination IP address from the ARP Cache. If it is located, MAC

address is known. Simply fill in the MAC address for transmission. If no corresponding IP address is found in ARP cache, Host A will send a broadcast. The MAC address is "FF.FF.FF.FF.FF.FF," which is to inquire all the host devices in the same network session about "What is the MAC address of "192.168.1.1"? Other host devices do not respond to the ARP inquiry except host device B, which responds to host device A when receiving this frame: "The MAC address of 192.168.1.1 is 00-aa-00-62-c6-09". So Host A knows the MAC address of Host B, and it can send data to Host B. Meanwhile, it will update its ARP cache.

Moreover, ARP virus attack can be briefly described as an internal attack to the PC, which causes trouble to the ARP table of the PC. In LAN, IP address was transferred into the second physical address (MAC address) through ARP protocol. ARP protocol is critical to network security. ARP cheating is caused by fake IP addresses and MAC addresses, and the massive ARP communications traffic will block the network. The MAC address from the fake source sends ARP response, attacking the high-speed cache mechanism of ARP. This usually happens to the cyber cafe users. Some or all devices in the shop experience temporal disconnection or failure of going online. It can be resolved by restarting the device; however, the problem repeats shortly after. Cafe Administrators can use `arp -a` command to check the ARP table. If the device IP and MAC are changed, it is the typical symptom of ARP virus attack.

Such virus program as PWSteal. lemir or its transformation is worm virus of the Trojan programs affecting Windows 95/ 98/ Me/ NT/ 2000/ XP/ 2003. There are two attack methods affecting the network connection speed: cheat on the ARP table in the device or LAN PC. The former intercepts the gateway data and send ceaselessly a series of wrong MAC messages to the device, which sends out wrong MAC address. The PC thus cannot receive the messages. The later is ARP attack by fake gateways. A fake gateway is established. The PC which is cheated sends data to this gateway and doesn't go online through the normal device. From the PC end, the situation is "disconnection".

For these two situations, the device and client setup must be done to prevent ARP virus attack, which is to guarantee the complete resolution of the issue. The device selection is advised to take into consideration the one with anti-ARP virus attack. Qno products come squarely with such a feature, which is very user-friendly compared to other products.

2. ARP Diagnostic

If one or more computers are affected by the ARP virus, we must learn how to diagnose and

take appropriate measures. The following is experience shared by Qno technical engineers with regard to the ARP prevention.

Through the ARP working principle, it is known that if the ARP cache is changed and the device is constantly notified with the series of error IP or if there is cheat by fake gateway, then the issue of disconnection will affect a great number of devices. This is the typical ARP attack. It is very easy to judge if there is ARP attack. Once users find the PC point where there is problem, users may enter the DOS system to conduct operation, pinging the LAN IP to see the packet loss. Enter the ping 192.168.1.1 (Gateway IP address) as illustrated.

```

Reply from 192.168.1.1: bytes=32 time<1ms TTL=64
Reply from 192.168.1.1: bytes=32 time<1ms TTL=64
Request timed out.
Request timed out.
Request timed out.
Request timed out.
Reply from 192.168.1.1: bytes=32 time<1ms TTL=64
Reply from 192.168.1.1: bytes=32 time<1ms TTL=64

```

If there are cases of packet loss of the ping LAN IP and if later there is connection, it is possible that the system is attacked by ARP. To verify the situation, we may judge by checking ARP table. Enter the ARP -a command as illustrated below.

```

Interface: 192.168.1.72 --- 0x2
Internet Address      Physical Address      Type
192.168.1.1          00-0f-3d-83-74-28    dynamic
192.168.1.43         00-13-d3-ef-b2-0c    dynamic
192.168.1.252        00-0f-3d-83-74-28    dynamic
C:\WINDOWS\System32>arp -a

```

It is found that the IP of 192.168.1.1 and 192.168.252 points to the same MAC address as 00-0f-3d-83-74-28. Evidently, this is a cheat by ARP.

3. ARP Solution

Now we understand ARP, ARP cheat and attack, as well as how to identify this type of attack. What comes next is to find out effective prevention measures to stop the network from being attacked. The general solution provided by Qno can be divided into the following three options:

a) Enable "Prevent ARP Virus Attack":

Enter the device IP address to log in the management webpage of the device.

Enter "Firewall-> General" and find the option "Prevent ARP Virus Attack" to the right of the page. Click on the option to activate it and click "Apply" at the bottom of the page (see illustrated).

Firewall :	<input checked="" type="radio"/> Enabled <input type="radio"/> Disabled
SPI (Stateful Packet Inspection) :	<input checked="" type="radio"/> Enabled <input type="radio"/> Disabled
DoS (Denial of Service) :	<input checked="" type="radio"/> Enabled <input type="radio"/> Disabled Advanced
Block WAN Request :	<input type="radio"/> Enabled <input checked="" type="radio"/> Disabled
Remote Management :	<input type="radio"/> Enabled <input checked="" type="radio"/> Disabled Port: <input type="text" value="80"/>
Multicast Pass Through :	<input type="radio"/> Enabled <input checked="" type="radio"/> Disabled
Prevent ARP Virus Attack :	<input checked="" type="radio"/> Enabled <input type="radio"/> Disabled Router sends ARP <input type="text" value="20"/> times per-second.

b) Bind the Gateway IP and MAC address for each PC

This prevents the ARP from cheating IP and its MAC address. First, find out the gateway IP and MAC address on the device end.

LAN Setting

MAC Address :	<input type="text" value="00"/> <input type="text" value="0c"/> <input type="text" value="41"/> <input type="text" value="00"/> <input type="text" value="00"/> <input type="text" value="01"/> (Default: 00-0c-41-00-00-01)
Device IP Address :	<input type="text" value="192"/> <input type="text" value="168"/> <input type="text" value="1"/> <input type="text" value="1"/>
Subnet Mask :	<input type="text" value="255"/> <input type="text" value="255"/> <input type="text" value="255"/> <input type="text" value="0"/>

On every PC, start or operate cmd to enter the dos operation. Enter arp -s 192.168.1.1 0a-0f-d4-9e-fb-0b so as to finish the binding of pc01 as illustrated.

```
Microsoft Windows XP [版本 5.1.2600]
(C) Copyright 1985-2001 Microsoft Corp.

C:\Documents and Settings\PM01>arp -s 192.168.1.1 1c-b1-80-9a-ce-20_
```

For other host devices within the network, follow the same way to enter the IP and MAC address of the corresponding device to complete the binding work. However, if this act restarts the computer, the setting will be cancelled. Therefore, this command can be regarded as a batch of processing documents placed in the activation of the operation system. The batch processing documents can be put in this way:

@echo off

arp -d

arp -s Router LAN IP Router LAN MAC

For those internal network attacked by Arp, the source must be identified. Method: If the PC fails to go online or there is packet loss of ping, in the DOS screen, input arp -a command to check if the MAC address of the gateway is the same with the device MAC address. If not, the PC corresponding to the MAC address is the source of attack.

Solutions for other device users are to make a two-way binding of the IP address and MAC address from both of the PC and device ends in order to carry out the prevention work. However, this is more complicated because the search for the IP and address and MAC increases the workload. Moreover, there is greater possibility of making errors during the operation.

c) Bind the IP/MAC Address from Device End:

Enter "Setup" under DHCP page. On the down right corner of the screen, there is "IP and MAC Binding," where users may create IP and MAC binding. On "Enabled," click on "✓" and select "Add to List." Repeat these steps to add other IP addresses and MAC binding, followed by clicking "Apply" at the bottom of the page.

IP & MAC Binding

[Show new IP user](#)

Static IP :

MAC Address : - - - - -

Name :

Enabled :

[Update this Entry](#)

192.168.1.110 => 00-4e-2d-b9-69-7e=>PC001=>Enabled

[Delete selected item](#) [Add](#)

Block MAC address on the list with wrong IP address

Block MAC address not on the list

[Show Table](#) [Apply](#) [Cancel](#)

After an item is added to the list, the corresponding message will be displayed in the white block on the bottom. However, such method is not recommended because the inquiry of IP/MAC addresses of all hosts creates heavy workload. Another method to bind IP and MAC is more recommended because of easy operation, reducing workload and time efficiency. It is described in the following.

Enter "Setup" under the DHCP page and look for IP and MAC binding. On the right, there is an option of "Show new IP user" and click to enter.

IP & MAC Binding

Show new IP user

Static IP: . . .

MAC Address: - - - - -

Name:

Enabled:

Add to list

Delete selected item

- Block MAC address on the list with wrong IP address.
- Block MAC address not on the list

Click to display IP and MAC binding list dialog box. In this box, the unbinding IP and MAC address corresponding to the PC are displayed. Enter the "Name" of the computer and click on "Enabled" with the display of the "√" icon and push the option on the top right corner of the screen to confirm.

IP Address	MAC Address	Name	Enabled
192.168.1.100	00:16:e6:50:13:32	<input type="text"/>	<input type="checkbox"/>

Apply
Select All
Refresh
Close

Now the bound options will display on the IP and MAC binding list (as illustrated in Figure 5) and click "Apply" to finish binding.

IP & MAC Binding

Show new IP user

Static IP:

MAC Address:

Name:

Enabled:

Update this Entry

192.138.1.110 => 00-20-ed-41-cb-9d=>PC001=>Enabled
192.168.1.130 => 00-3e-4a-6d-3d-24=>PC002=>Enabled

Delete selected item
Add

- Block MAC address on the list with wrong IP address
- Block MAC address not on the list

Show Table
Apply
Cancel

Though these basic operations can help solve the problem but Qno's technical engineers suggest that further measures should be taken to prevent the ARP attack.

1. Deal with virus source as well as the source device affected by virus through virus killing and the system re-installation. This operation is more important because it solves the source PC which is attacked by ARP. This can better shelter the network from being attacked.
2. Cyber café administrators should check the LAN virus, install anti-virus software (Ginshan Virus/Reixin must update the virus codes) and conduct virus scanning for the device.
3. Install the patch program for the system. Through Windows Update, the system patch program (critical update, security update and Service Pack)
4. Provide system administrators with a sophisticated and strong password for different accounts. It would be best if the password consists of a combination of more than 12 letters, digits, and symbols. Forbid and delete some redundant accounts.

5. Frequently update anti-virus software (virus data base), and set the daily upgrade that allows regular and automatic update. Install and use the network firewall software. Network firewall is important for the process of anti-virus. It can effectively avert the attack from the network and invasion of the virus. Some users of the pirate version of Windows cannot install patches successfully. Users are advised to use network firewall and other measures for protection.

6. Close some unnecessary services and some unnecessary sharing (if the condition is applicable), which includes such management sharing as C\$ and D\$. Single device user can directly close Server service.

7. Do not open QQ or the link messages sent by MSN online chatting tools in a causal manner. Do not open or execute any strange, suspicious documents, and procedures such as the unknown attachment enclosed in E-mail and plug-in.

4. Summary

ARP attack prevention is a serious and long-term undertaking. The above methods can basically resolve the network problems caused by ARP virus attack. Moreover, clients who adopted similar methods witness good results. However, it is important that network administrators pay special attention to this problem rather than overlooking the issue. It is suggested that the above measures can be adopted to prevent ARP attack, reduce the damage, enhance the work efficiency, and minimize economic loss.

Appendix III : Qno Technical Support Information

For more information about the Qno's product and technology, please log onto the Qno's bandwidth forum, refer to the examples of the FTP server, or contact the technical department of Qno's dealers as well as the Qno's Mainland technical center.

Qno Official Website

[http : //www.Qno.com.tw](http://www.Qno.com.tw)

Dealer Contact

Users may log on to the service webpage to check the contacts of dealers.

[http : //www.qno.com.tw/web/where_buy.asp](http://www.qno.com.tw/web/where_buy.asp)

Taiwan Support Center :

E- mail : QnoFAE@qno.com.tw